

Communication Protocol Interface Guide

A Series

Anesthesia System

mindray

This publication contains data proprietary to Mindray DS USA, Inc. It is provided solely for use by qualified personnel to interface external devices with certain Mindray devices. Mindray DS USA, Inc. assumes no responsibility for any adverse interaction resulting from the use of this protocol, or for any regulatory issues that may be raised by connecting devices. The details of this protocol are subject to change at any time, without prior notice.

© Mindray DS USA, Inc., 2013. All rights reserved. Contents of this publication may not be reproduced in any form without permission of Mindray DS USA, Inc.

Table of Contents

1 Overview	1-1
1.1 Introduction	1-1
1.2 References	1-2
1.3 Physical Connections	1-3
1.3.1 Network Port.....	1-3
1.3.2 Serial Port.....	1-4
1.4 Interface Protocols	1-5
1.4.1 DEC Profile: Unsolicited Results	1-5
1.4.2 CT Profile: Time Synchronization	1-5
1.5 Use Cases.....	1-6
1.6 Applicable Scope.....	1-7
2 Communication Protocol Layers.....	2-1
2.1 Introduction to the A Series Export Protocol.....	2-1
2.1.1 Physical Layers	2-1
2.1.2 TCP Layer	2-3
3 System Setup	3-1
3.1 Anesthesia System Setup	3-1
3.1.1 Network Port Setup	3-2
3.1.2 Serial Protocol Setup.....	3-3
3.1.3 Demographics Setup.....	3-4
3.2 Time Synchronization Setup.....	3-5
4 A Series Export Protocol	4-1
4.1 DEC Profile: Unsolicited Results	4-1
4.1.1 Supported Transmission Data	4-2
4.1.2 Message Details: PCD-01	4-3
4.1.3 DEC Message Example	4-11
4.1.4 Networking	4-15
5 Time Synchronization.....	5-1
5.1 CT (Consistent Time) Profile:	5-1
5.2 Introduction to the SNTP Protocol.....	5-2
5.2.1 UDP Layer.....	5-2
5.2.2 Packet Assembly.....	5-3
5.2.3 SNTP C/S Illustration	5-4

A CRC Calculation.....	A-1
A.1 Overview.....	A-1
A.2 CRC Calculation Guidance.....	A-1
B A Series HL7 Export Nomenclature	B-1
B.1 General ID Allocation Scheme for “99MNDRY” Terms.....	B-1
B.2 A Series - Anesthesia Machine Containment Tree.....	B-2
B.3 Units of Measure.....	B-3
B.4 Ventilator / Anesthesia Machine Settings IDs	B-4
B.5 Ventilation Modes.....	B-5
B.6 System Status.....	B-6
B.7 Patient Measurements	B-7
B.8 Ventilator / Anesthesia Machine Measurement IDs	B-8
B.9 Airway Gas Analyzer Measurement IDs.....	B-9
C A Series HL7 Simulator Instructions.....	C-1
C.1 Overview.....	C-1
C.2 Simulator Setup	C-1
C.3 Keyboard Shortcuts	C-3

1 Overview

1.1 Introduction

This guide is intended to be used by software developers and/or systems integrators that wish to communicate with Mindray A Series anesthesia systems that have software bundle version 02.02.00 and later. Future versions of firmware may support additional measurements, settings and/or modes.

The A Series Anesthesia Systems can communicate measurements and settings to other systems such as clinical IT systems. This is done using an HL7 based protocol based on the Integrating the Healthcare Enterprise (IHE) Patient Care Devices (PCD) Device to Enterprise Communication (DEC) profile. This document provides specifics on how the A Series Anesthesia Systems implement this profile.

1.2 References

- HL7 V2.6
- IHE PCD Technical Framework Volume 1
- IHE PCD Technical Framework Volume 2
- IHE ITI Technical Framework Volume 1
- IHE ITI Technical Framework Volume 2
- IHE PCD Rosetta Terminology Profile
- ISO/IEEE 11073-10101 Nomenclature
- IETF RFC 2030 SNTP

1.3 Physical Connections

The A Series anesthesia system can communicate via the Network Port and the Serial Port. Both ports can be used simultaneously.

1.3.1 Network Port

The A Series anesthesia system can communicate using Ethernet. A standard 10/100 Base-T connector is located at the back of the machine for this purpose. Refer to the illustration below:

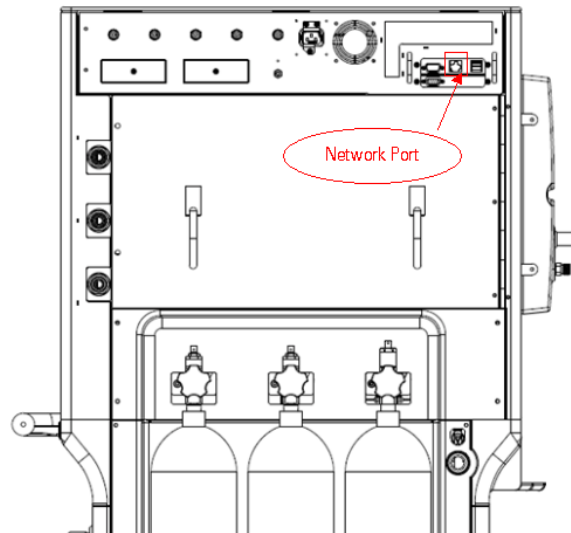

1.3.2 Serial Port

The A Series anesthesia system can communicate using a Serial Port. A RS-232 asynchronous serial interface is located at the back of the machine for this purpose. Refer to the illustration below:

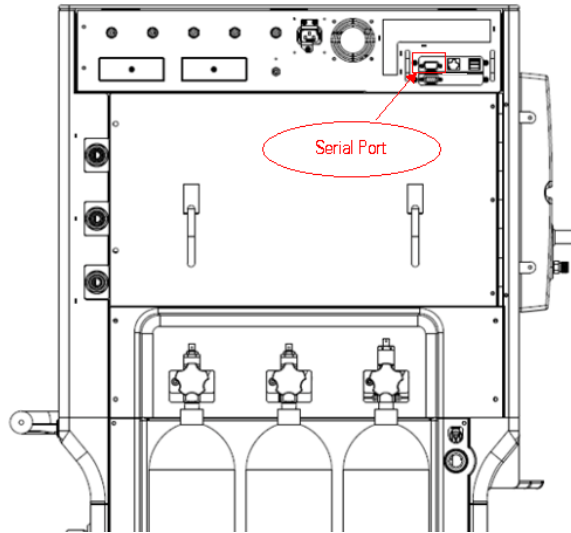

1.4 Interface Protocols

The messaging protocols used by the A Series anesthesia systems are based on profiles established by the Integrating the Healthcare Enterprise (IHE) organization Patient Care Devices (PCD) domain. Two different profiles are supported.

1.4.1 DEC Profile: Unsolicited Results

The A Series supports sending unsolicited results at a 10 second interval. Shorter or longer intervals are allowed by configuration.

1.4.2 CT Profile: Time Synchronization

The A Series device supports the IHE Consistent Time (CT) Profile (ITI-01) only on the Ethernet port.

This profile supports the synchronization of time between a Time Server and a Time Client and is based on the IETF standard SNTP protocol. The Time Client periodically transmits synchronization request (using UDP) to the Time Server. The request interval as well as IP Address of the Time Server is configured on the Anesthesia System.

1.5 Use Cases

There are two general Use Cases that have been considered in development of the A Series Interface Protocol:

1. Point-to-Point:

Interface of an A Series Anesthesia System (DOR) directly to a local data consumer (DOC) such as a patient monitoring system or clinical information system. This scenario can be implemented via either the Serial Port (RS232) connection or the Network Port (Ethernet) using a point-to-point topology.

It is unlikely that the DOC will also support the Time Server functionality, so that any data collected by the DOC should be time-stamped by the DOC as of the time of receipt. In a point-to-point scenario, the DOC is also responsible for associating the data with the appropriate patient.

2. Networked:

Interface of an A Series Anesthesia System over a network using the Network Port to a DOC which is typically a clinical IT system. In this case the network probably also has a network Time Server which the Anesthesia System can use to synchronize its clock.

In this situation it is also very important that the system end-user associate the device with the proper patient either through location or through entry of key patient demographics into the A Series anesthesia system.

1.6 Applicable Scope

Currently, only the DEC and CT profiles are applicable to the A Series anesthesia system.

FOR YOUR NOTES

2 Communication Protocol Layers

2.1 Introduction to the A Series Export Protocol

The Export protocol used by the Mindray anesthesia systems is based on the technical framework specified by the IHE (Integrated Healthcare Enterprise) PCD (Patient Care Device) domain.

The syntax is based on HL7 and the semantic system used is based on ISO/IEEE 11073-10101 as documented in the IHE PCD Rosetta Profile to the extent that Reference IDs and codes are published for A Series measurements and settings. If not available, then a Private code set has been used which will be substituted for Standards based sets when they are available.

While the HL7 protocol defines the syntax of a message it does not specify the framing (beginning and end) of a message. To mark the beginning and end boundaries of a message, the Minimal Lower Layer Protocol (MLLP, refer to HL7 Interface Standards Version 2.5.1) developed by the HL7 organization is used.

2.1.1 Physical Layers

2.1.1.1 RS-232 Physical Layer and Framing

The RS-232 port by default is configured to a 115200 Baud Rate, 8 Data bits, 1 Stop bit, Parity of none, and no flow control. The A Series allows configuration of other settings with a minimum baud rate of 57600. The Data bits must always be 8-bits. Message error checking is done via a CRC mechanism.

MLLP is used to denote the beginning and end of the message. MLLP is the Minimal Lower Layer Protocol which is used by HL7 for delimiting the start and end of a message.

The structure of an MLLP message is:

<SB> + <Message> + <CRC> + <EB> + <CR>

Where:

<SB> = Start Block (0x0B (VT))

<Message> = Optimized IHE-PCD HL7 Message

<EB> = End Block (0x1C (FS))

<CR> = Carriage return (0x0D (CR))

<CRC> = 16 bit CRC in 4 ASCII characters (see Appendix A).

A 16-bit CRC checksum of the message content (not including the MLLP framing information (SB, EB, and CR)) is appended at the end of any message. For more information refer to Appendix A.

A typical message will look like:

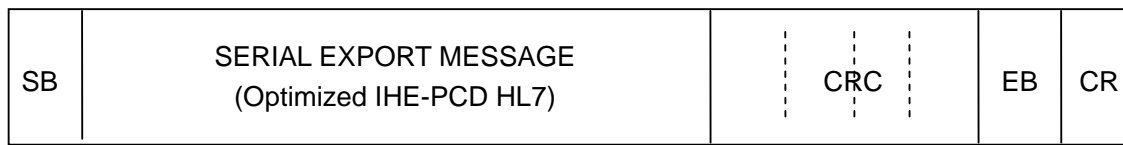

2.1.1.2 Ethernet Framing

The Ethernet protocol has a built in CRC check so that each message does not need any application level checking for transmission errors. MLLP is used for message start and end delimiting on top of TCP/IP. MLLP is the Minimal Lower Layer Protocol which is used by HL7 for delimiting the start and end of a message.

The structure of an MLLP message is:

<SB> + <Message> + <EB> + <CR>

Where:

<SB> = Start Block (0x0B (VT))

<Message> = IHE-PCD compliant HL7 Message

<EB> = End Block (0x1C (FS))

<CR> = Carriage Return (0x0D (CR))

A typical message will look like:

SB	NETWORK EXPORT MESSAGE (IHE-PCD HL7)	EB	CR
----	---	----	----

2.1.2 TCP Layer

The Figure below shows the Network communication layers involved in the communication between Mindray anesthesia systems and communication partners.

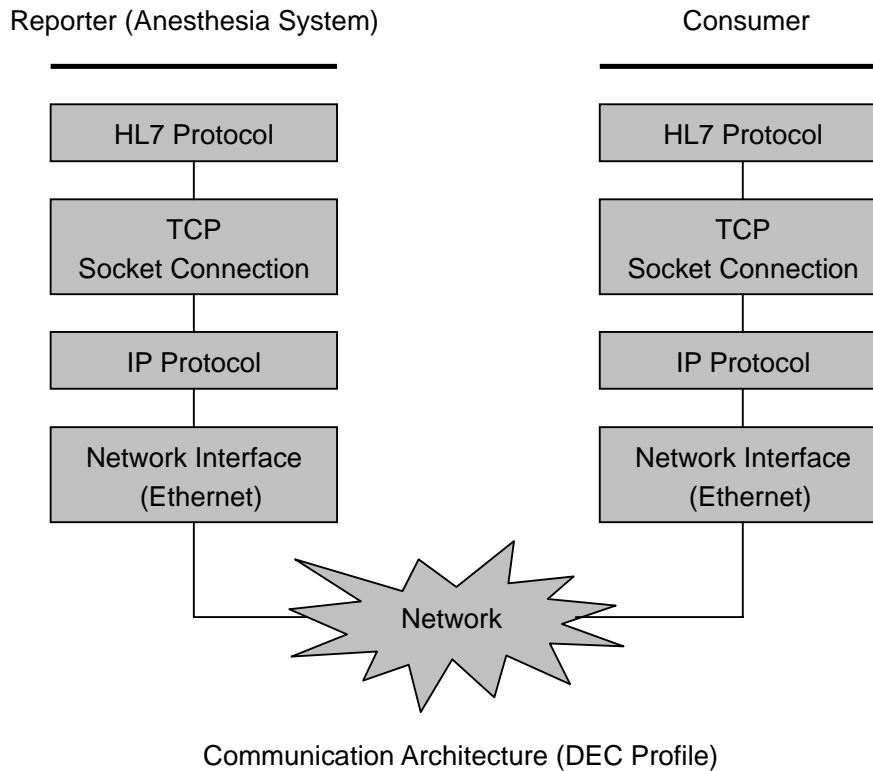

Corresponding to “TCP” layer in the Communication Architecture (DEC Profile).

- Connection-oriented Socket Service
- Use TCP/IP stack protocol
- Ethernet driver interface
- All networking information (IP, Port , Subnet, Gateway) is entered by the user manually

FOR YOUR NOTES

3 System Setup

3.1 Anesthesia System Setup

Before the anesthesia systems can communicate with a Data Consumer, the system must be properly configured as explained in this section. Please note that both the Serial port and the Network port can be used simultaneously, if desired, to connect to two different data consumers.

3.1.1 Network Port Setup

The technical user can enable the DOR function and configure the transmission frequency and server IP and port information via the user interface shown below (inside the red highlighted area). The A Series Anesthesia Systems network port can only communicate with one DOC at a time (i.e. the device must be reconfigured to talk to a different DOC).

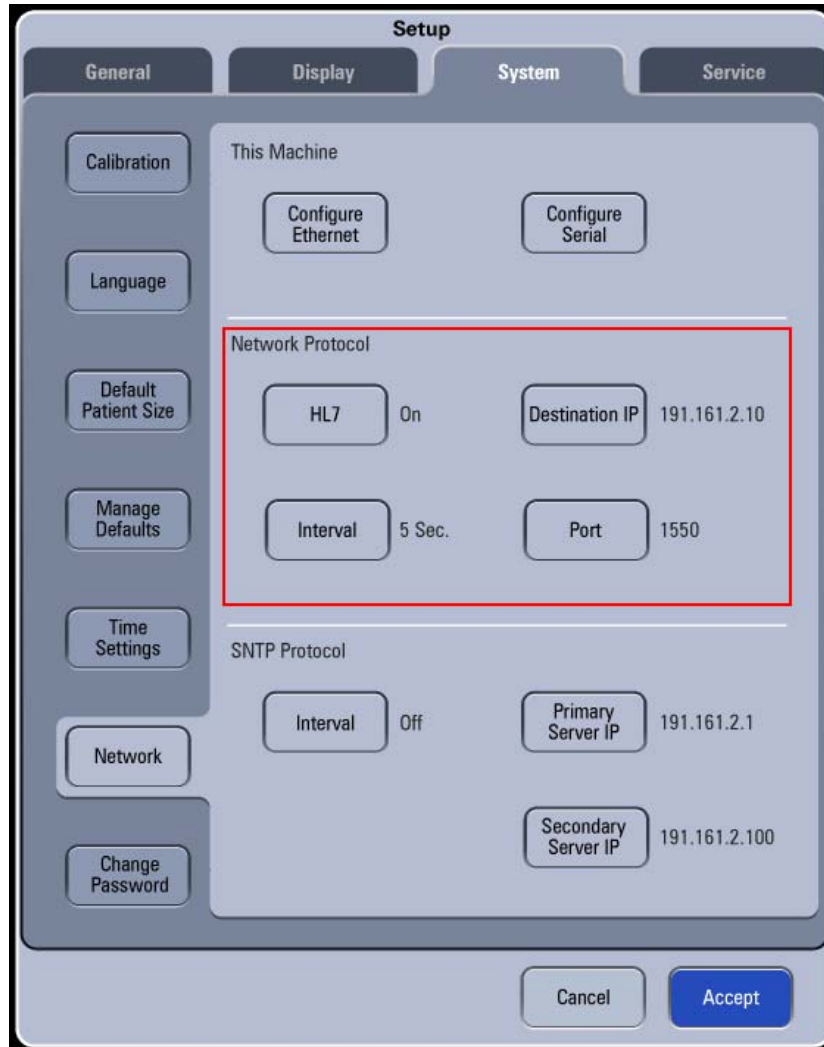

The message reporting interval can be set to 10 Sec, 30 Sec, 1 Min, 5 Min, 30 Min, 1 Hour, 2 Hour, 6 Hour, 12 Hour or 24 Hour.

3.1.2 Serial Protocol Setup

The technical user can choose whether the serial port will communicate using the HL7 (MR-Link) protocol, the MR-WATO protocol or be turned off. The MR-WATO protocol is for Mindray internal use only.

When the Protocol selection is set to “None”, the DOR function using the serial port will be disabled.

When the Protocol selection is set to “HL7”, the user can configure the transmission frequency, Baud Rate, Stop bit (1 or 2) and Parity via the user interface shown below (Pushing the Configure Serial button to enter this dialog). No flow control and the Data bits must always be 8-bits. The A Series Anesthesia System serial port can only communicate with one DOC at a time when the serial connection is established.

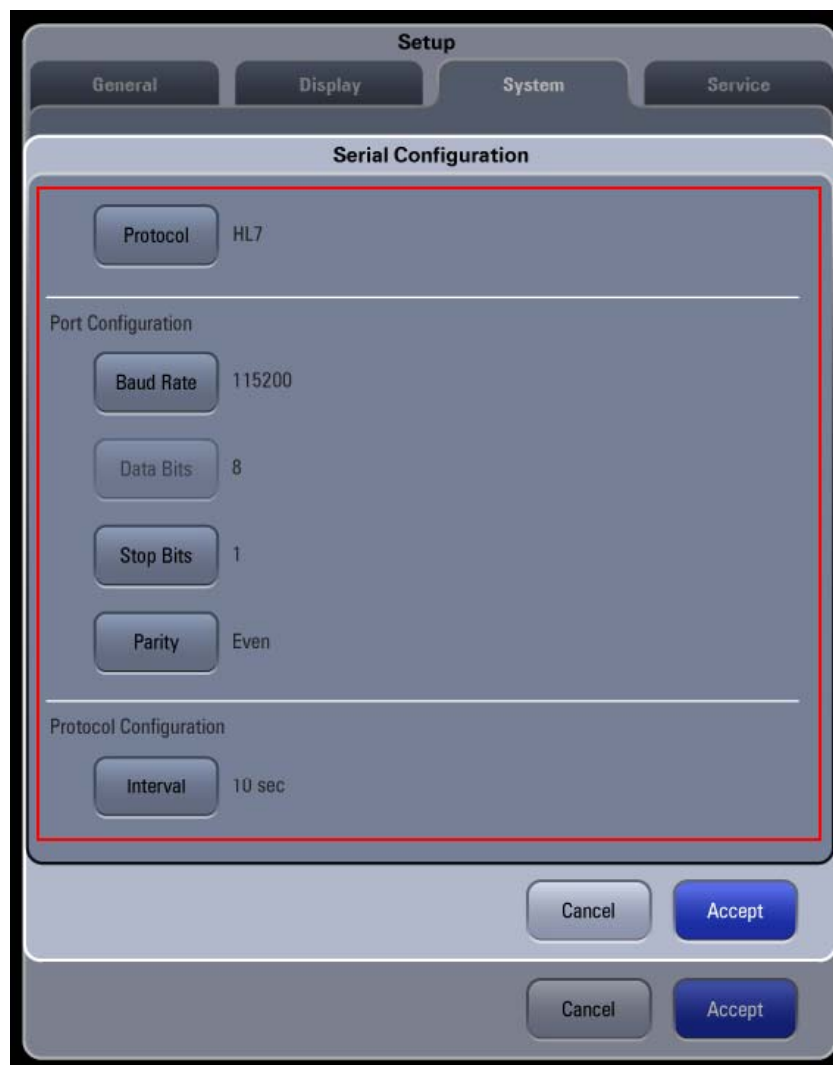

The message reporting interval can be set to 10 Sec, 30 Sec, 1 Min, 5 Min, 30 Min, 1 Hour, 2 Hour, 6 Hour, 12 Hour or 24 Hour.

3.1.3 Demographics Setup

The demographics information can be entered by user via the menu below. Patient ID, First Name, Last Name DOB and Weight are patient demographic data. Bed, Room, Point of Care and Facility are hospital demographic data. This demographic information will be transferred in the DEC profile message.

The screenshot shows a software interface with three tabs: Waveforms, Spirometry, and Demographics. The Demographics tab is active and contains the following fields:

Field Name	Value
Patient ID	
Bed	02
First Name	
Room	C6-505
Last Name	
Point of Care	Care AA
DOB	
Weight (Lbs.)	
Facility	Hospital XX
Age ---	

If the A Series device is installed in a network topology, a minimum set of demographics data must be entered so that the receiving system can associate the device with the correct patient. Different receiving systems have different requirements. Note that hospital demographic data will not be deleted or changed unless the user changes it which should occur whenever the A Series device changes location. Patient demographic data will be reset to "EMPTY" whenever the patient is discharged.

3.2 Time Synchronization Setup

The A Series anesthesia system is compliant with the SNTP protocol.

The technical user can set the synchronization frequency and server information corresponding to the role of CT Client information via the user interface shown below (inside the red highlighted area).

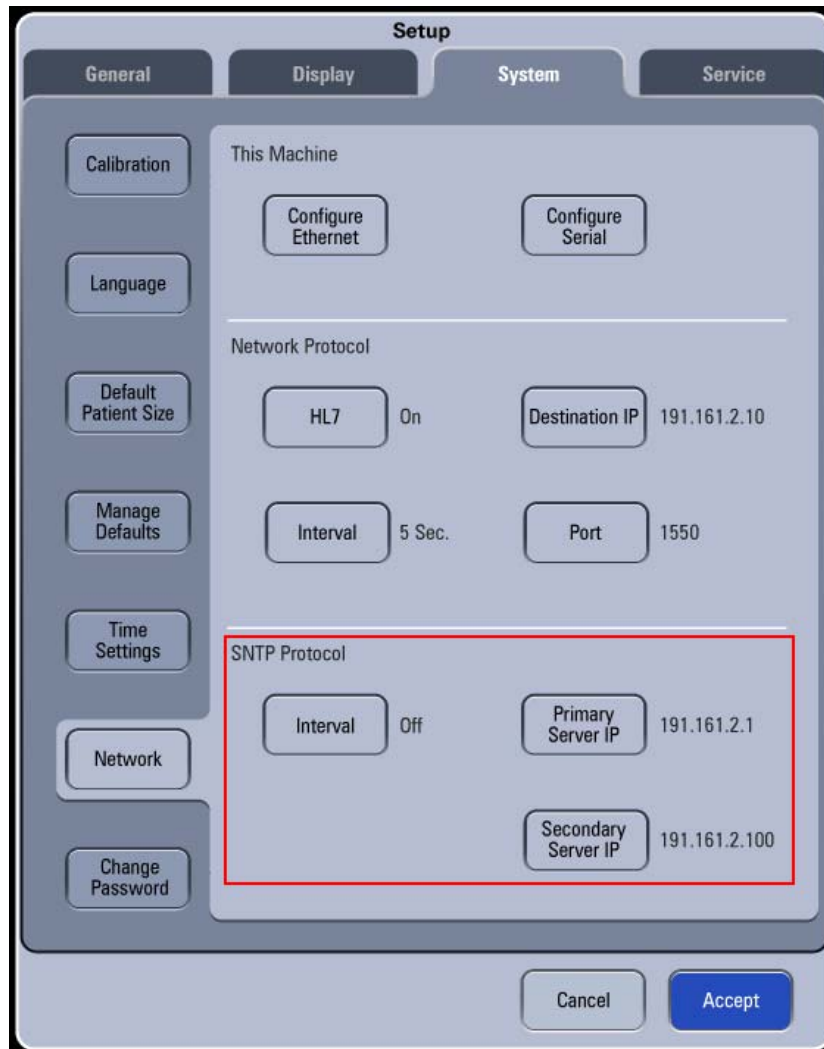

The technical user can configure the following:

- Interval: defines the time interval at which A Series request the standard time periodically.
- Primary Server IP: defines the IP address of Primary Time Server.
- Secondary Server IP: defines the IP address of Secondary Time Server.

The time synchronize interval can be set to Off, 10 Sec, 30 Sec, 1 Min, 5 Min, 30 Min, 1 Hour, 2 Hour, 6 Hour, 12 Hour or 24 Hour.

Please note that if this function is set to “off” then the time-stamp requests sent to the time server by the Anesthesia System will stop and the CT profile will be disabled.

If the function is set to “on” and a Time Server is not available, the Anesthesia System will try to connect repeatedly according to the configured interval. If the connection attempt fails 5 times in a row, the Anesthesia System will display a “Could not locate time server” prompt message, this prompt message will be displayed until the connection attempt succeeds.

The Port of Time Server is fixed to 123.

UTC Time in System->Time Settings tab shall be used to calculate the time offset.

4 A Series Export Protocol

4.1 DEC Profile: Unsolicited Results

The A Series supports sending unsolicited results at a 10 second interval. Shorter or longer intervals are allowed by configuration. The Device Observation Reporter (DOR) (Mindray device) will continue to send unsolicited results at its configured interval independent of whether or not an ACK was received from the Device Observation Consumer (DOC). In Serial Port mode, the Ack (see Figure below) is not expected.

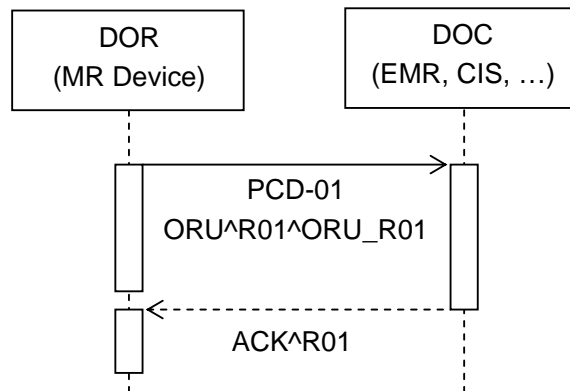

Unsolicited Results sequence Diagram

4.1.1 Supported Transmission Data

The Mindray anesthesia system acts in the role of a DOR in the IHE PCD DEC Profile architecture. It transmits the working data (measurements, settings, vent modes, status, etc.) periodically to the DOC (receiver). Please refer to Appendix B to get more details.

4.1.1.1 Notes

- In Standby mode, the A Series anesthesia system does not send any ventilation information such as: ventilation mode, ventilation parameter measurements or settings.
- In ACGO mode, Manual mode or Auto Ventilation Non-Functional state ventilation parameter settings are not sent. ACGO mode is used on the A7 only.
- The A Series anesthesia system will not send the parameters generated by an external or internal AG module unless they are connected. The external AG module is an optional configuration for the A5 and a standard configuration for the A7. The internal AG module is only on the A7.
- The actual agent measurements are only sent when the external AG module is connected and the system is not in Standby mode. The external AG module is an optional configuration for the A5 and a standard configuration for the A7.
- In all modes, all five of the cumulative agent usage values are sent when the internal AG module is connected. The internal AG module is only on the A7.
- When the A Series anesthesia system is working in ACGO or Monitor mode, it will not send the Rate that is measured by the ventilator (VCM). It will send the Rate that is measured by AG module if the external AG module is connected. Monitor mode is an optional configuration for the A5 and a standard configuration for the A7. ACGO mode is used on the A7 only.
- When the A Series anesthesia system is in Auto Ventilation Non-Functional state, the measured parameters from the external AG module are still sent. The external AG module is an optional configuration for the A5 and a standard configuration for the A7.
- The A Series anesthesia system will send out fresh gas flow setting parameters only when the EFCS is in use. EFCS is the Electronic Fresh Gas System used on A7 only. This is the standard method to control flow on the A7 anesthesia system. The desired flow is set by the user and proportional valves will achieve the set flow.
- The A Series anesthesia system will send out fresh gas flow measured parameters except when the BFCS is in use. BFCS is the backup fresh gas system used on the A7 only. This is the backup method to control flow on the anesthesia system. The flow cannot be preset to a particular value, the flow is increased or decreased by the user by turning mechanical valves.

4.1.2 Message Details: PCD-01

As described previously, the PCD-01 message profile was developed by the IHE PCD Domain for the reporting of results such as Respiration Rate, Airway Pressure, SpO2, etc.

This message is made up of the following segments:

- MSH Segment - Message Header
- PID Segment - Patient Identifier
- PV1 Segment - Patient Visit
- OBR Segment - Observation Request
- OBX Segment - Observation Results

4.1.2.1 Unsolicited Parameter Observations (ORU^R01^ORU_R01)

The A Series device sends the ORU^R01^ORU_R01 message to report physiological results to the system connected to it when in Unsolicited Results mode.

The default segment grammar for this transaction is MSH {PID PV1 {OBR [{OBX}]}}

Segment	Meaning	Usage	Cardinality
MSH	Message Header	R	[1..1]
{	--- PATIENT_RESULT begin	R	[1..1]
PID	Patient Identification	R	[1..1]
PV1	Patient Visit	O	[0..1]
{	---ORDER_OBSERVATION begin	R	[1..1]
OBR	Observation Request	R	[1..1]
[--- PARAMETER begin	O	[0..1]
{OBX}	Parameter Observation	R	[1..*]
]	--- PARAMETER end		
}	---ORDER_OBSERVATION end		
}	--- PATIENT_RESULT end		

Table 1 PCD-01 Message Definition

4.1.2.2 MSH Segment

The MSH segment defines the intent, source, destination, and some specifics of the syntax of a message.

The A Series Export protocol supports 2 versions of the MSH Segment. The “Network Port” version complies with the IHE-PCD PCD-01 profile, whereas the “Serial Port” version is optimized for a reduced data rate and reduces the number of required fields while still using an IHE-PCD PCD-01 HL7 based syntax. It is a pure subset of the Network Port protocol.

MSH Segment Definition:

Field	Name	Mindray Usage on Network Port		Mindray Usage on Network Serial	
			Content		Content
MSH-1	Field Separator	R	“ ”	R	“ ”
MSH-2	Encoding Characters	R	“^~\&”	R	“^~\&”
MSH-3	Sending Application	R		R	
MSH-3.1	Namespace ID	R	“MINDRAY_A-SERIES”	R	“MINDRAY_A-SERIES”
MSH-3.2	Universal ID	R	Mindray Device ID ¹	R	Mindray Device ID ¹
MSH-3.3	Universal ID Type	R	“EUI-64”	R	“EUI-64”
MSH-4	Sending Facility	RE	Facility entered	X	EMPTY
MSH-5	Receiving Application	X	EMPTY	X	EMPTY
MSH-6	Receiving Facility	X	EMPTY	X	EMPTY
MSH-7	Date/Time of Message	R	YYYY[MM[DD[HH[MM[SS]]]]] [+/-ZZZZ]	R	YYYY[MM[DD[HH[MM[SS]]]]] [+/-ZZZZ]
MSH-9	Message Type	R		X	EMPTY
MSH-9.1	Message Code	R	“ORU”		
MSH-9.2	Trigger Event	R	“R01”		
MSH-9.3	Message Structure	R	“ORU_R01”		
MSH-10	Message Control Id	R	Incremented value	R	Incremented value
MSH-11	Processing Id	R		X	EMPTY
MSH-11.1	Processing ID	R	“P”		EMPTY
MSH-11.2	Processing Mode	X	EMPTY		EMPTY
MSH-12	Version ID	R	“2.6”	R	“2.6”
MSH-13	Sequence Number	X	EMPTY	X	EMPTY
MSH-14	Continuation Pointer	X	EMPTY	X	EMPTY
MSH-15	Accept Acknowledgment Type	R	“NE”	X	EMPTY
MSH-16	Application Acknowledgment Type	R	“AL”	X	EMPTY
MSH-17	Country Code	X	EMPTY	X	EMPTY
MSH-18	Character Set	RE	“UNICODE UTF-8”	X	EMPTY

Field	Name	Mindray Usage on Network Port		Mindray Usage on Network Serial	
			Content		Content
MSH-19	Principal Language Of Message	X	EMPTY	X	EMPTY
MSH-20	Alternate Character Set Handling Scheme	X	EMPTY	X	EMPTY
MSH-21	Message Profile Identifier	R		R	
MSH-21.1	Entity Identifier	R	"IHE_PCD_001"	R	"PCD_001"
MSH-21.2	Namespace ID	RE	"IHE PCD"	X	EMPTY
MSH-21.3	Universal ID	RE	"1.3.6.1.4.1.19376.1.6.1.1.1"	X	EMPTY
MSH-21.4	Universal ID Type	RE	"ISO"	X	EMPTY

Table 2 MSH Segment

Note: Fields that are not used are omitted for brevity.

¹Mindray Device ID:

The Mindray Device ID is an EUI-64 identifier with the following format:

"00A037" + 4 digit device type code¹ + unique six digit value

The value "00A037" is Mindrays unique global ID. The 4 digit device type code identifies the device type, its values can be found in Table 3. The unique six digit value is serial number unique to the device.

Device	Code
A3	"0028"
A5	"0029"
A7	"002A"

Table 3 Device Type Codes

4.1.2.3 PID Segment

The PID segment is used as the primary means of communicating patient identification information. This segment contains permanent patient identifying and demographic information that, for the most part, is not likely to change frequently.

PID Segment Definition:

Field	Name	Mindray Usage on Network Port		Mindray Usage on Network Serial	
			Content		Content
PID-3	Patient Identifier List	R		R	
PID-3.1	ID Number	R	Patient ID entered	R	Patient ID entered
PID-3.4	Assigning Authority	R	Facility entered	X	EMPTY
PID-3.5	Identifier Type Code	R	"PI"	X	EMPTY
PID-3.6	Assigning Facility	X	EMPTY	X	EMPTY
PID-5	Patient Name	O		O	
PID-5.1	Family Name	O	Last Name entered	RE	Last Name entered
PID-5.2	Given Name	O	First Name entered	RE	First Name entered
PID-5.3	Second and Further Given Names	X	EMPTY	X	EMPTY
PID-5.4	Suffix	X	EMPTY	X	EMPTY
PID-5.5	Prefix	X	EMPTY	X	EMPTY
PID-5.7	Name Type Code	R	"L"	X	EMPTY
PID-5.8	Name Representation Code	X	EMPTY	X	EMPTY
PID-6	Mother's Maiden Name	X	EMPTY	X	EMPTY
PID-7	Date/Time of Birth	RE	DOB entered (YYYY[MM[DD]])	RE	DOB entered (YYYY[MM[DD]])
PID-8	Administrative Sex	RE	EMPTY	RE	EMPTY
PID-10	Race	RE	EMPTY	RE	EMPTY

Table 4 PID Segment Definition

Note: Fields that are not used are omitted for brevity.

4.1.2.4 PV1 Segment

The PV1 segment is used to communicate information on an account or visit-specific basis.

PV1 Segment Definition:

Field	Name	Mindray Usage on Network Port		Mindray Usage on Network Serial	
			Content		Content
PV1-2	Patient Class	R	"I"	R	"I"
PV1-3	Assigned Location	RE		RE	
PV1-3.1	Point of Care	RE	Point of Care entered	X	EMPTY
PV1-3.2	Room	RE	Room entered	RE	Room entered
PV1-3.3	Bed	RE	Bed entered	RE	Bed entered
PV1-3.4	Facility	RE	Facility entered	X	EMPTY
PV1-3.5	Location Status	X	EMPTY	X	EMPTY
PV1-3.6	Person Location Type	X	EMPTY	X	EMPTY
PV1-3.7	Building	X	EMPTY	X	EMPTY
PV1-3.8	Floor	X	EMPTY	X	EMPTY
PV1-3.9	Location Description	X	EMPTY	X	EMPTY
PV1-3.10	Comprehensive Location Identifier	X	EMPTY	X	EMPTY
PV1-3.11	Assigning Authority for Location	X	EMPTY	X	EMPTY

Table 5 PV1 Segment Definition

Note: Fields that are not used are omitted for brevity.

4.1.2.5 OBR Segment

The OBR segment is used to transmit a date and time of the OBX segments which follow.

OBR Segment Definition:

Field	Name	Mindray Usage on Network Port		Mindray Usage on Network Serial	
			Content		Content
OBR-1	Set ID OBR	R	Incremented value	R	Incremented value
OBR-2	Placer Order Number	R		X	EMPTY
OBR-2.1	Entity identifier	R	Same as MSH-10		
OBR-2.2	Namespace ID	R	Same as MSH-3.1		
OBR-2.3	Universal ID	R	Same as MSH-3.2		
OBR-2.4	Universal ID Type	R	"EUI-64"		
OBR-3	Filler Order Number	R		X	EMPTY
OBR-3.1	Entity identifier	R	Same as OBR-2.1		
OBR-3.2	Namespace ID	R	Same as OBR-2.2		
OBR-3.3	Universal ID	R	Same as OBR-2.3		
OBR-3.4	Universal ID Type	R	"EUI-64"		
OBR-4	Universal Service Identifier	R		X	EMPTY
OBR-4.1	Identifier	R	"70040"		
OBR-4.2	Text	R	"MDC_DEV_SYS_ANESTH"		
OBR-4.3	Naming of Coding System	R	"MDC"		
OBR-7	Observation Date/Time	RE	YYYY[MM[DD[HH[MM[SS]]]]] [+/-ZZZZ]	RE	YYYY[MM[DD[HH[MM[SS]]]]]

Table 6 OBR Segment Definition

Note: Fields that are not used are omitted for brevity.

4.1.2.6 OBX Segment

The OBX segment is used to transmit a single observation or observation fragment. It represents the smallest indivisible unit of a report.

OBX Segment Definition:

Field	Name	Mindray Usage on Network Port		Mindray Usage on Network Serial	
			Content		Content
OBX-1	Set ID-OBX	R	Incremented value	R	Incremented value
OBX-2	Value Type	CE	See Table 8	CE	See Table 8
OBX-3	Observation Identifier	R		R	
OBX-3.1	Identifier	R	See section B.4 - B.9	R	See section B.4 - B.9
OBX-3.2	Text	R	See section B.4 - B.9	R	EMPTY
OBX-3.3	Name of Coding System	R	See section B.4 - B.9	R	See section B.4 - B.9
OBX-3.4	Alternate Identifier	X	EMPTY	X	EMPTY
OBX-3.5	Alternate Text	X	EMPTY	X	EMPTY
OBX-3.6	Alternate Coding System	X	EMPTY	X	EMPTY
OBX-4	Observation Sub-ID	R	See section B.4 - B.9	X	EMPTY
OBX-5	Observation Value	CE	Observation Value	CE	Observation Value
OBX-6	Units	CE		CE	
OBX-6.1	Identifier	R	See section B.3	R	See section B.3
OBX-6.2	Text	R	See section B.3	X	EMPTY
OBX-6.3	Coding system	R	See section B.3	R	See section B.3
OBX-7	Reference Range	X	EMPTY	X	EMPTY
OBX-8	Abnormal Flags	CE	See Table 9	X	EMPTY
OBX-11	Observation Result Status	R	See Table 9	R	EMPTY
OBX-14	Date/Time of the Observation	RE	YYYY[MM[DD[HH[MM[SS]]]]] [+/-ZZZZ]	RE	EMPTY
OBX-16	Responsible Observer	X	EMPTY	X	EMPTY
OBX-17	Observation Method	X	EMPTY	X	EMPTY
OBX-18	Equipment Instance Identifier	X	EMPTY	X	EMPTY
OBX-19	Data/Time of Analysis	CE	EMPTY	CE	EMPTY
OBX-20	Observation Site	RE	EMPTY	RE	EMPTY

Table 7 OBX Segment definition

Note: Fields that are not used are omitted for brevity.

Value Types

Value Type	OBX-2	Description
Numerical	"NM"	This is used to represent simple numeric values such as 1.23
Structured Numeric	"SN"	This is used to represent structured numerics such as ratios. For example an I:E ratio of 1:2 would be sent as ^1^:^2 For details on this type refer to the HL7 Version 2.6 Standard.
Coded Entry	"CWE"	This is for coded entries such as vent modes and system status where OBX-5 is not a simple value but a coded value. For example: 50013^MNDRY_MODE_PCV_PLUS_VG^99MNDRY

Table 8 Value Types

Observation Status	OBX-8	OBX-11	Description
Invalid	"INV"	"X"	The observation is not available
Valid, Unconfirmed	EMPTY	"R"	The observation was machine measured but not confirmed by a clinician
Valid, Confirmed by user	EMPTY	"F"	The observation was confirmed by a clinician

Table 9 Observation Status

4.1.3 DEC Message Example

The following is an example of a complete Anesthesia System message for both communication modes (Network and Serial), conforming to the IHE DEC profile.

4.1.3.1 Network Port Example

```
MSH|^~\&|MINDRAY_A-SERIES^00A0370029000033^EUI-64|NEW TOWN|||20120912194537+0800|ORU^R01^ORU_R01|57|P|2.6||NE|AL||UNICODE UTF-8||IHE_PCD_001^IHE PCD^1.3.6.1.4.1.19376.1.6.1.1.1^ISO
PID||3423^^^NEW TOWN^PI||Mike^Bill^^^^L||19500912|
PV1|||ICU^3A^10^NEW TOWN
OBR|1|57^MINDRAY_A-SERIES^00A0370029000033^EUI-64|57^MINDRAY_A-SERIES^00A0370029000033^EUI-64|70040^MDC_DEV_SYS_ANESTH^MDC|||20120912194537+0800|
OBX|1|CWE|268422^MDC_EVT_STAT_DEV^MDC|1.1.1.268422|268438^MDC_EVT_STAT_RUNNING^MDC|262656^MDC_DIM_DIMLESS^MDC||||F|||20120912194537+0800|
OBX|2|CWE|30002^MNDRY_EVT_STAT_MODE_DEV^99MNDRY|1.1.1.30002|30003^MNDRY_EVT_STAT_MODE_NORMAL^99MNDRY|262656^MDC_DIM_DIMLESS^MDC||||F|||20120912194537+0800|
OBX|3|CWE|30005^MNDRY_EVT_PATIENT_TYPE^99MNDRY|1.1.1.30005|268424^MDC_EVT_STAT_DEV_MODE_PEDIATRIC^MDC|262656^MDC_DIM_DIMLESS^MDC||||F|||20120912194537+0800|
OBX|4|CWE|30007^MNDRY_EVT_STAT_WARMER_ON_BOOL^99MNDRY|1.3.1.30007|30000^MDC_TRUE^99MNDRY|262656^MDC_DIM_DIMLESS^MDC||||F|||20120912194537+0800|
OBX|5|CWE|184352^MDC_VENT_MODE^MDC|1.3.1.184352|50005^MNDRY_VENT_MODE_VCV^99MNDRY|262656^MDC_DIM_DIMLESS^MDC||||F|||20120912194537+0800|
OBX|6|NM|151868^MDC_VOL_AWAY_TIDAL_SETTING^MDC|1.3.2.151868|300|263762^MDC_DIM_MILLI_L^MDC||||F|||20120912194537+0800|
OBX|7|NM|151586^MDC_VENT_RESP_RATE_SETTING^MDC|1.3.2.151586|30|264928^MDC_DIM_RESP_PER_MIN^MDC||||F|||20120912194537+0800|
OBX|8|SN|20000^MDC_RATIO_IE_SETTING^99MNDRY|1.3.2.20000|^1^2|262656^MDC_DIM_DIMLESS^MDC||||F|||20120912194537+0800|
OBX|9|NM|20007^MNDRY_VENT_PAUSE_TIME_PERCENT_SETTING^99MNDRY|1.3.2.20007|0|262688^MDC_DIM_PERCENT^MDC||||F|||20120912194537+0800|
OBX|10|NM|151976^MDC_PRESS_AWAY_END_EXP_POS_SETTING^MDC|1.3.2.151976|0|266048^MDC_DIM_CM_H2O^MDC||||F|||20120912194537+0800|
OBX|11|NM|20013^MNDRY_VENT_PRESS_LIMIT_SETTING^99MNDRY|1.3.2.20013|45|266048^MDC_DIM_CM_H2O^MDC||||F|||20120912194537+0800|
OBX|12|NM|113^MDC_FLOW_O2_FG^99MNDRY|1.3.3.113|3.7|265216^MDC_DIM_L_PER_MIN^MDC||||R|||20120912194537+0800|
OBX|13|NM|114^MDC_FLOW_N2O_FG^99MNDRY|1.3.3.114|0.00|265216^MDC_DIM_L_PER_MIN^MDC||||R|||20120912194537+0800|
OBX|14|NM|115^MDC_FLOW_AIR_FG^99MNDRY|1.3.3.115|1.9|265216^MDC_DIM_L_PER_MIN^MDC||||R|||20120912194537+0800|
OBX|15|NM|151957^MDC_VENT_PRESS_MAX^MDC|1.3.2.151957|11|266048^MDC_DIM_CM_H2O^MDC||||R|||20120912194537+0800|
OBX|16|NM|151819^MDC_PRESS_AWAY_INSP_MEAN^MDC|1.3.2.151819|6|266048^MDC_DIM_CM_H2O^MDC||||R|||20120912194537+0800|
```

OBX|17|NM|151784^MDC_PRESS_RESP_PLAT^MDC|1.3.2.151784|10|266048^MDC_DIM_CM_H2O^MDC||||R||20120912194537+0800|

OBX|18|NM|151976^MDC_PRESS_AWAY_END_EXP_POS^MDC|1.3.2.151976|3|266048^MDC_DIM_CM_H2O^MDC||||R||20120912194537+0800|

OBX|19|NM|151880^MDC_VOL_MINUTE_AWAY^MDC|1.3.2.151880|2.2|265216^MDC_DIM_L_PER_MIN^MDC||||R||20120912194537+0800|

OBX|20|NM|151868^MDC_VOL_AWAY_TIDAL^MDC|1.3.2.151868|67|263762^MDC_DIM_MILLI_L^MDC||||R||20120912194537+0800|

OBX|21|NM|151586^MDC_VENT_RESP_RATE^MDC|1.3.2.151586|31|264928^MDC_DIM_RESP_PER_MIN^MDC||||R||20120912194537+0800|

OBX|22|SN|151832^MDC_RATIO_IE^MDC|1.3.2.151832|^4.5^|^1|262656^MDC_DIM_DIMLESS^MDC||||R||20120912194537+0800|

OBX|23|NM|151840^MDC_RES_AWAY^MDC|1.3.2.151840|2|268064^MDC_DIM_CM_H2O_PER_L_PER_SEC^MDC||||R||20120912194537+0800|

OBX|24|NM|151688^MDC_COMPL_LUNG^MDC|1.3.2.151688|8|268050^MDC_DIM_MILLI_L_PER_CM_H2O^MDC||||R||20120912194537+0800|

OBX|25|NM|152196^MDC_CONC_AWAY_O2_INSP^MDC|1.4.1.152196|23|262688^MDC_DIM_PERCENT^MDC||||R||20120912194537+0800|

OBX|26|NM|188736^MDC_MASS_BODY_ACTUAL^MDC|1.2.1.188736|55.0|263875^MDC_DIM_KILO_G^MDC||||F||20120912194537+0800|

OBX|27|NM|151708^MDC_CONC_AWAY_CO2_ET^MDC|1.4.1.151708|12|266016^MDC_DIM_MMHG^MDC||||R||20120912194537+0800|

OBX|28|NM|151716^MDC_CONC_AWAY_CO2_INSP^MDC|1.4.1.151716|9|266016^MDC_DIM_MMHG^MDC||||R||20120912194537+0800|

OBX|29|NM|152440^MDC_CONC_AWAY_O2_ET^MDC|1.4.1.152440|20|262688^MDC_DIM_PERCENT^MDC||||R||20120912194537+0800|

OBX|30|NM|152108^MDC_CONC_AWAY_N2O_ET^MDC|1.4.1.152108|0|262688^MDC_DIM_PERCENT^MDC||||R||20120912194537+0800|

OBX|31|NM|152192^MDC_CONC_AWAY_N2O_INSP^MDC|1.4.1.152192|0|262688^MDC_DIM_PERCENT^MDC||||R||20120912194537+0800|

OBX|32|NM|119^MDC_CONC_MAC^99MNDRY|1.4.1.119|0.0|262656^MDC_DIM_DIMLESS^MDC||||R||20120912194537+0800|

OBX|33|NM|152088^MDC_CONC_AWAY_ENFL_ET^MDC|1.4.1.152088|0.7|262688^MDC_DIM_PERCENT^MDC||||R||20120912194537+0800|

OBX|34|NM|152172^MDC_CONC_AWAY_ENFL_INSP^MDC|1.4.1.152172|1.0|262688^MDC_DIM_PERCENT^MDC||||R||20120912194537+0800|

OBX|35|NM|152084^MDC_CONC_AWAY_DESFL_ET^MDC|1.4.1.152084|0.4|262688^MDC_DIM_PERCENT^MDC||||R||20120912194537+0800|

OBX|36|NM|152168^MDC_CONC_AWAY_DESFL_INSP^MDC|1.4.1.152168|0.6|262688^MDC_DIM_PERCENT^MDC||||R||20120912194537+0800|

OBX|37|NM|126^MDC_VOL_DELIV_HALOTH_LIQUID_CASE^99MNDRY|1.4.1.126|0.00|263762^MDC_DIM_MILLI_L^MDC||||R||20120912194537+0800|

OBX|38|NM|127^MDC_VOL_DELIV_ENFL_LIQUID_CASE^99MNDRY|1.4.1.127|0.00|263762^MDC_DIM_MILLI_L^MDC||||R||20120912194537+0800|

OBX|39|NM|128^MDC_VOL_DELIV_ISOFL_LIQUID_CASE^99MNDRY|1.4.1.128|0.00|263762^MDC_DIM_MILLI_L^MDC||||R||20120912194537+0800|

OBX|40|NM|129^MDC_VOL_DELIV_SEVOFL_LIQUID_CASE^99MNDRY|1.4.1.129|0.00|263762^MDC_DIM_MILLI_L^MDC||||R||20120912194537+0800|

OBX|41|NM|130^MDC_VOL_DELIV_DESFL_LIQUID_CASE^99MNDRY|1.4.1.130|0.00|263762^MDC_DIM_MILLI_L^MDC||||R||20120912194537+0800|

4.1.3.2 Serial Port Example

MSH|^~\&|MINDRAY_A-SERIES^00A0370029000033^EUI-64|||20120912194737+0800||70|2.6|||||PCD_001PID||3423||Mike^ Bill||19500912|

PV1|||^3A^10

OBR|1|||20120912194737|

OBX|1|CWE|268422^^MDC||268438^MDC_EVT_STAT_RUNNING^MDC|262656^^MDC|

OBX|2|CWE|30002^^99MNDRY||30003^MNDRY_EVT_STAT_MODE_NORMAL^99MNDRY|262656^^MDC|

OBX|3|CWE|30005^^99MNDRY||268424^MDC_EVT_STAT_DEV_MODE_PEDIATRIC^MDC|262656^^MDC|

OBX|4|CWE|30007^^99MNDRY||30000^MDC_TRUE^99MNDRY|262656^^MDC|

OBX|5|CWE|184352^^MDC||50005^MNDRY_VENT_MODE_VCV^99MNDRY|262656^^MDC|

OBX|6|NM|151868^^MDC||300|263762^^MDC|

OBX|7|NM|151586^^MDC||30|264928^^MDC|

OBX|8|SN|20000^^99MNDRY||^1^:^2|262656^^MDC|

OBX|9|NM|20007^^99MNDRY||0|262688^^MDC|

OBX|10|NM|151976^^MDC||0|266048^^MDC|

OBX|11|NM|20013^^99MNDRY||45|266048^^MDC|

OBX|12|NM|113^^99MNDRY||3.7|265216^^MDC|

OBX|13|NM|114^^99MNDRY||0.00|265216^^MDC|

OBX|14|NM|115^^99MNDRY||1.9|265216^^MDC|

OBX|15|NM|151957^^MDC||11|266048^^MDC|

OBX|16|NM|151819^^MDC||6|266048^^MDC|

OBX|17|NM|151784^^MDC||10|266048^^MDC|

OBX|18|NM|151976^^MDC||3|266048^^MDC|

OBX|19|NM|151880^^MDC||2.2|265216^^MDC|

OBX|20|NM|151868^^MDC||67|263762^^MDC|

OBX|21|NM|151586^^MDC||31|264928^^MDC|

OBX|22|SN|151832^^MDC||^4.2^:^1|262656^^MDC|

OBX|23|NM|151840^^MDC||2|268064^^MDC|
OBX|24|NM|151688^^MDC||8|268050^^MDC|
OBX|25|NM|152196^^MDC||23|262688^^MDC|
OBX|26|NM|188736^^MDC||55.0|263875^^MDC|
OBX|27|NM|151708^^MDC||12|266016^^MDC|
OBX|28|NM|151716^^MDC||9|266016^^MDC|
OBX|29|NM|152440^^MDC||20|262688^^MDC|
OBX|30|NM|152108^^MDC||0|262688^^MDC|
OBX|31|NM|152192^^MDC||0|262688^^MDC|
OBX|32|NM|119^^99MNDRY||0.0|262656^^MDC|
OBX|33|NM|152088^^MDC||0.7|262688^^MDC|
OBX|34|NM|152172^^MDC||1.0|262688^^MDC|
OBX|35|NM|152084^^MDC||0.4|262688^^MDC|
OBX|36|NM|152168^^MDC||0.6|262688^^MDC|
OBX|37|NM|126^^99MNDRY||0.00|263762^^MDC|
OBX|38|NM|127^^99MNDRY||0.00|263762^^MDC|
OBX|39|NM|128^^99MNDRY||0.00|263762^^MDC|
OBX|40|NM|129^^99MNDRY||0.00|263762^^MDC|
OBX|41|NM|130^^99MNDRY||0.00|263762^^MDC|

4.1.4 Networking

4.1.4.1 C/S Status Diagram

After system initiation, Mindray anesthesia system attempts to connect with the target server periodically. Once connection with the target server succeeds, Mindray anesthesia system transmits data as per the preset cycle. If network failure occurs, Mindray anesthesia system clears the previous state and re-initiates a connection request.

DEC client work process:

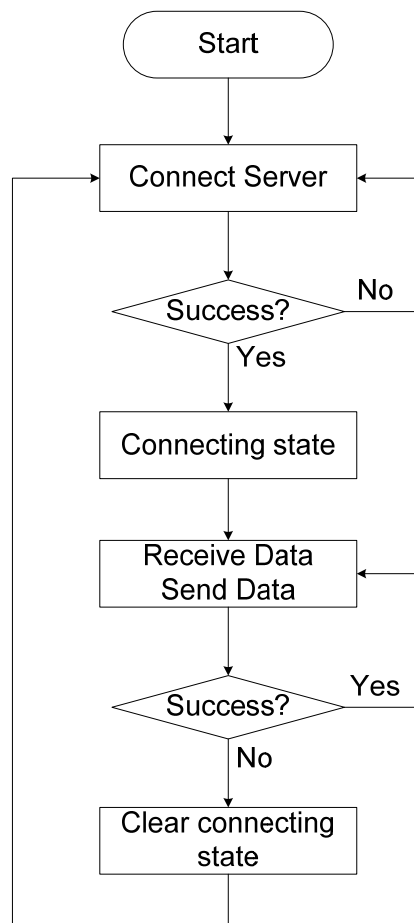

FOR YOUR NOTES

5 Time Synchronization

5.1 CT (Consistent Time) Profile:

The A Series device supports the IHE Consistent Time (CT) Profile (ITI-01) only on the Ethernet port.

This profile supports the synchronization of time between a Time Server and a Time Client and is based on the IETF standard SNTP protocol. The Time Client periodically transmits synchronization request (using UDP) to the Time Server. The request interval as well as IP Address of the Time Server is configured on the Anesthesia System.

The A Series anesthesia machines play a Time Client role in the IHE CT profile.

If a Time Server is not available then the Anesthesia System will try to connect again after the configured interval. If the connection attempt fails 5 times in a row, the Anesthesia System will display a “Could not locate time server” prompt message. This prompt message will be displayed until the connection attempt succeeds.

IHE ITI Time Client application system architecture:

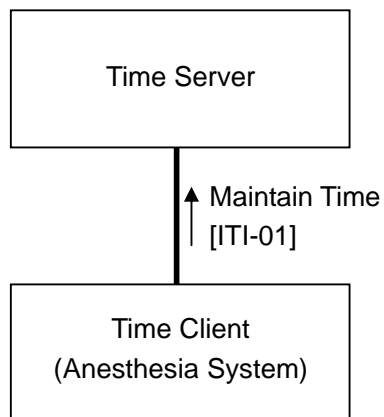

5.2 Introduction to the SNTP Protocol

As mentioned previously, when the Network Port is used the A Series can use the IHE Consistent Time (CT) profile to obtain system time. This profile uses SNTP which is simple network protocol based on RFC 2030. It uses the same protocol as NTP except the unique difference that SNTP does not include measurement data which the NTP high-accuracy data estimation algorithm uses. The SNTP protocol is applicable to hosts which do not require a full implementation of the NTP complex algorithm. SNTP is a subset of NTP, it uses UDP protocol with “well-known” port of 123.

The Mindray anesthesia system acts as a Client in this Client/Server system, however it does initiate the requests to the server. The message format is as follows:

0			7		15		23		31
LI	VN	Mode		Stratum		Poll Interval		Precision	
Root Delay (32)									
Root Dispersion (32)									
Reference Identifier (32)									
Reference Timestamp (64)									
Originate Timestamp (64)									
Receive Timestamp (64)									
Transmit Timestamp (64)									

For a definition of each field in an SNTP message, refer to “*RFC 2030 Simple Network Protocol*”.

5.2.1 UDP Layer

The figure below shows the Network communication layers involved in the communication between Mindray anesthesia systems and communication partners.

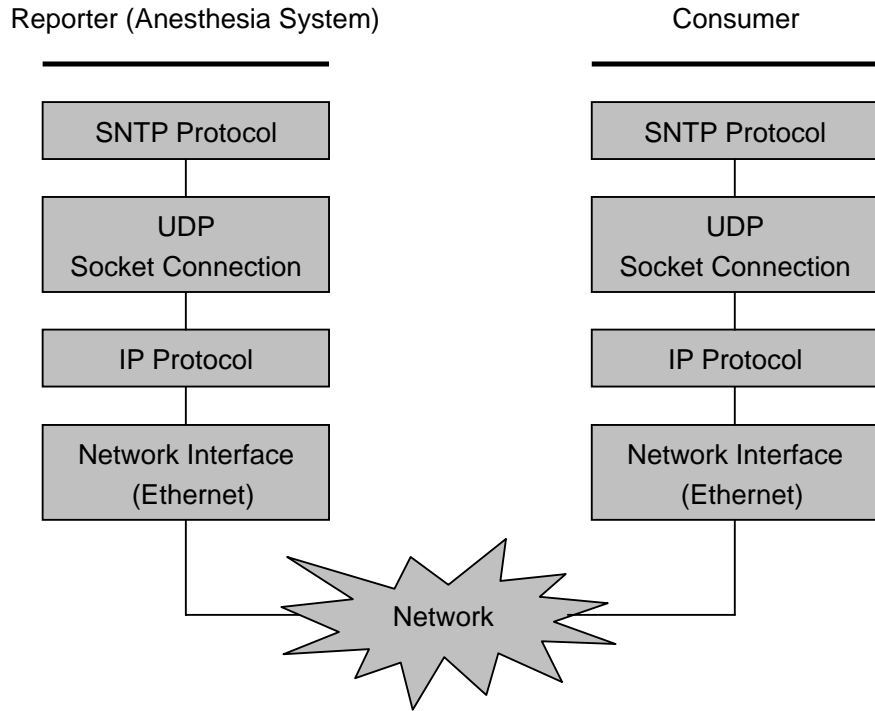

Communication Architecture (CT Profile)

Corresponding to “UDP” layer in the Communication Architecture (CT Profile).

- Connectionless Socket Service
- Use TCP/IP stack protocol
- Ethernet driver interface
- All networking information (IP address, Subnet, Gateway) is entered by the user manually

5.2.2 Packet Assembly

SNTP data format that SNTP contains 48 bytes which are divided into five parts: SNTP header, time stamp T1, time stamp T2, time stamp T3, and time stamp T4.

Header information: configuration information of the current sender

- T1: time point when Client sends a request
- T2: time point when Server receives the request
- T3: time point when Server sends a response
- T4: time point when Client receives the response

As Client, Mindray anesthesia system only sends request packets. The request packet mainly contains header information and T1 time stamp. The following gives an example of a completed request packet.

0		7		15		23		31	
00	011	011	00000000		00000000		00000000		
0x00000000									
0x00000000									
0x00000000									
0x00000000					0x00000000				
0x00000000					0x00000000				
0x00000000					0x00000000				
0xD0C2D77D					0x00000000				

Note: 0xD0C2D77D represent the UTC time of 2010-12-27 9 :14 :37.

After receiving this message, the Time Server fills T2 time stamp and T3 time stamp. Then it sends the assembled new data packet back to the Client for time synchronization to the master clock.

5.2.3 SNTP C/S Illustration

CT client work illustration:

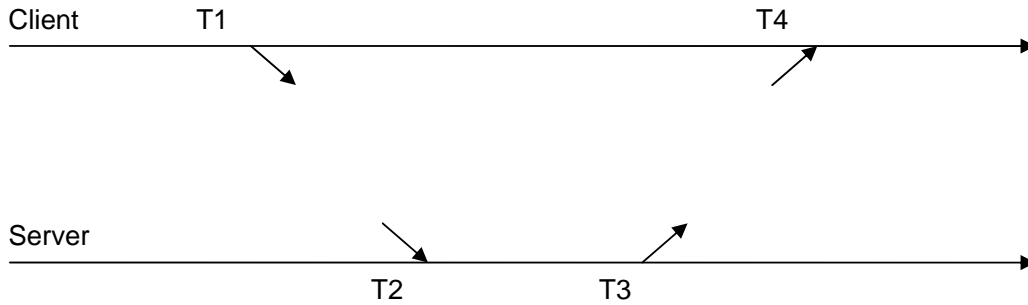

Note: for time calibration algorithm, refer to “RFC 2030 Simple Network Protocol”.

A CRC Calculation

A.1 Overview

As depicted in section 2.1.1.1 the Serial Protocol uses a CRC based on the IETF RFC 1171 for HDLC framing. The CRC is calculated to 16 bits on the HL7 message and does not include the MLLP framing characters. It is inserted towards the end of the Serial export message using 4 ASCII characters in Hex. For example if the CRC is 0x1F2Eh, the CRC is inserted as 1F2E.

A.2 CRC Calculation Guidance

Below is a C++ class for reference that performs the CRC based on the IETF RFC 1171 for HDLC framing. It can easily be converted into a C function if needed.

```
class CRC
{
private:
    static unsigned short s_CRCTable[256];
    unsigned short m_Value;

public:
    CRC():m_Value(0){}
    unsigned short GetValue() const { return m_Value;}
    void Reset() {m_Value = 0;}
    void Calculate( const unsigned char* data, size_t length);
};
```

```
const unsigned short CRC::s_CRCTable[256] =
{
0x0000, 0x1189, 0x2312, 0x329b, 0x4624, 0x57ad, 0x6536, 0x74bf,
0x8c48, 0x9dc1, 0xaf5a, 0xbed3, 0xca6c, 0xdbe5, 0xe97e, 0xf8f7,
0x1081, 0x0108, 0x3393, 0x221a, 0x56a5, 0x472c, 0x75b7, 0x643e,
0x9cc9, 0x8d40, 0xbfdb, 0xae52, 0xdaed, 0xcb64, 0xf9ff, 0xe876,
0x2102, 0x308b, 0x0210, 0x1399, 0x6726, 0x76af, 0x4434, 0x55bd,
0xad4a, 0xbcc3, 0x8e58, 0x9fd1, 0xeb6e, 0xfae7, 0xc87c, 0xd9f5,
0x3183, 0x200a, 0x1291, 0x0318, 0x77a7, 0x662e, 0x54b5, 0x453c,
0xbdcb, 0xac42, 0x9ed9, 0x8f50, 0xfbef, 0xea66, 0xd8fd, 0xc974,
0x4204, 0x538d, 0x6116, 0x709f, 0x0420, 0x15a9, 0x2732, 0x36bb,
0xce4c, 0xdfc5, 0xed5e, 0xfcd7, 0x8868, 0x99e1, 0xab7a, 0xbaf3,
```

```
0x5285, 0x430c, 0x7197, 0x601e, 0x14a1, 0x0528, 0x37b3, 0x263a,
0xdecd, 0xcf44, 0xfddf, 0xec56, 0x98e9, 0x8960, 0xbbfb, 0xaa72,
0x6306, 0x728f, 0x4014, 0x519d, 0x2522, 0x34ab, 0x0630, 0x17b9,
0xef4e, 0xfec7, 0xcc5c, 0xdd5, 0xa96a, 0xb8e3, 0x8a78, 0x9bf1,
0x7387, 0x620e, 0x5095, 0x411c, 0x35a3, 0x242a, 0x16b1, 0x0738,
0xffcf, 0xee46, 0xdcdd, 0xcd54, 0xb9eb, 0xa862, 0x9af9, 0x8b70,
0x8408, 0x9581, 0xa71a, 0xb693, 0xc22c, 0xd3a5, 0xe13e, 0xf0b7,
0x0840, 0x19c9, 0x2b52, 0x3adb, 0x4e64, 0x5fed, 0x6d76, 0x7cff,
0x9489, 0x8500, 0xb79b, 0xa612, 0xd2ad, 0xc324, 0xf1bf, 0xe036,
0x18c1, 0x0948, 0x3bd3, 0x2a5a, 0x5ee5, 0x4f6c, 0x7df7, 0x6c7e,
0xa50a, 0xb483, 0x8618, 0x9791, 0xe32e, 0xf2a7, 0xc03c, 0xd1b5,
0x2942, 0x38cb, 0x0a50, 0x1bd9, 0x6f66, 0x7eef, 0x4c74, 0x5dfd,
0xb58b, 0xa402, 0x9699, 0x8710, 0xf3af, 0xe226, 0xd0bd, 0xc134,
0x39c3, 0x284a, 0x1ad1, 0x0b58, 0x7fe7, 0x6e6e, 0x5cf5, 0x4d7c,
0xc60c, 0xd785, 0xe51e, 0xf497, 0x8028, 0x91a1, 0xa33a, 0xb2b3,
0x4a44, 0x5bcd, 0x6956, 0x78df, 0x0c60, 0x1de9, 0x2f72, 0x3efb,
0xd68d, 0xc704, 0xf59f, 0xe416, 0x90a9, 0x8120, 0xb3bb, 0xa232,
0x5ac5, 0x4b4c, 0x79d7, 0x685e, 0x1ce1, 0x0d68, 0x3ff3, 0x2e7a,
0xe70e, 0xf687, 0xc41c, 0xd595, 0xa12a, 0xb0a3, 0x8238, 0x93b1,
0x6b46, 0x7acf, 0x4854, 0x59dd, 0x2d62, 0x3ceb, 0x0e70, 0x1ff9,
0xf78f, 0xe606, 0xd49d, 0xc514, 0xb1ab, 0xa022, 0x92b9, 0x8330,
0x7bc7, 0x6a4e, 0x58d5, 0x495c, 0x3de3, 0x2c6a, 0x1ef1, 0x0f78
};
```

```
void UInt16FCS::Calculate( const unsigned char* data, size_t length)
{
    const unsigned char* endPtr = data + length;
    while(data < endPtr)
        m_Value = (m_Value >> 8) ^ s_CRCTable[(m_Value ^ *data++) & 0xff];
}
```

B A Series HL7 Export Nomenclature

B.1 General ID Allocation Scheme for “99MNDRY” Terms

Wherever possible Standards based 11073-10101 terms have been used. These are denoted by “MDC” as OBX 3.3. In situations where terms were not yet available we have developed a Private code space which is denoted by “99MNDRY”.

Range	Purpose
00000 – 09999	Measurements
10000 – 19999	Units of Measure (UoM)
20000 – 29999	Settings
30000 – 39999	Status
40000 – 49999	Body Sites

B.2 A Series - Anesthesia Machine Containment Tree

Anesthesia System Containment Tree						
MDS	Anesthesia System			1	1	
	VMD	Anesthesia System			0.1	1.1
		Channel	Status	..1	1.1.1	
	VMD	Body Measurement			0.2	1.2
		Channel	Measurement	..1	1.2.1	
	VMD	Ventilator			0.3	1.3
		Channel	Status	..1	1.3.1	
		Channel	Ventilation	..2	1.3.2	
		Channel	Fresh Gas	..3	1.3.3	
	VMD	Airway Gas Analyzer			0.4	1.4
		Channel	Airway Gas	..1	1.4.1	
	VMD	BIS Monitor			0.5	1.5
		Channel	BIS	..1	1.5.1	

B.3 Units of Measure

Unit of Measure	OBX-6.1 UCode10	OBX-6.1 Code + Offset	OBX-6.2 RefID	OBX-6.3 Code System	Comment
l/min	3072	265216	MDC_DIM_L_PER_MIN	MDC	
ml	1618	263762	MDC_DIM_MILLI_L	MDC	
cmH2O	3904	266048	MDC_DIM_CM_H2O	MDC	
s	2176	264320	MDC_DIM_SEC	MDC	
kg	1728+3	263875	MDC_DIM_KILO_G	MDC	Gram*10**3
cmH2O/l/s	5920	268064	MDC_DIM_CM_H2O_PER_L_PER_SEC	MDC	
ml/cmH2O	5888+18	268050	MDC_DIM_MILLI_L_PER_CM_H2O	MDC	
mmHg	3872	266016	MDC_DIM_MMHG	MDC	
Hz	2496	264640	MDC_DIM_HZ	MDC	
/min	2528	264672	MDC_DIM_PER_MIN	MDC	
rpm	2784	264928	MDC_DIM_RESP_PER_MIN	MDC	
bpm	2720	264864	MDC_DIM_BEAT_PER_MIN	MDC	
dB	6432	268576	MDC_DIM_DECIBEL	MDC	
DimLess	512	262656	MDC_DIM_DIMLESS	MDC	No Unit of Measure
%	544	262688	MDC_DIM_PERCENT	MDC	
uV	4256+19	266419	MDC_DIM_MICRO_VOLT	MDC	Volt*10**-6

B.4 Ventilator / Anesthesia Machine Settings IDs

Send only settings that are valid for a specific device mode

Parameter	OBX-3.1 Code	OBX-3.2 RefID	OBX-3.3	Unit of Measure	OBX-4	Module	Comment
I:E	20000	MDC_RATIO_IE_SETTING	99MNDRY	DimLess	1.3.2.C	Vent.	
Trigger	20014	MDC_VENT_PRESS_TRIG_SENS_SETTING	99MNDRY	l/min	1.3.2.C	Vent.	
Vt	20015	MDC_VOL_AWAY_TIDAL_SETTING	99MNDRY	ml	1.3.2.C	Vent.	
Rate	20016	MDC_VENT_RESP_RATE_SETTING	99MNDRY	rpm	1.3.2.C	Vent.	
MinRate	20001	MNDRY_RESP_RATE_MIN_SETTING	99MNDRY	rpm	1.3.2.C	Vent.	
PEEP	20017	MDC_PRESS_AWAY_END_EXP_POS_SETTING	99MNDRY	cmH2O	1.3.2.C	Vent.	
Plimit	20013	MNDRY_VENT_PRESS_LIMIT_SETTING	99MNDRY	cmH2O	1.3.2.C	Vent.	
Pinsp	20002	MNDRY_VENT_PRESS_INSP_SETTING	99MNDRY	cmH2O	1.3.2.C	Vent.	
Δ P	20003	MNDRY_VENT_DELTA_PRESS_SETTING	99MNDRY	cmH2O	1.3.2.C	Vent.	
Tinsp	20004	MNDRY_VENT_INSP_TIME_SETTING	99MNDRY	s	1.3.2.C	Vent.	
Tslope	20005	MNDRY_VENT_SLOPE_TIME_SETTING	99MNDRY	s	1.3.2.C	Vent.	
VtG	20006	MNDRY_VENT_TIDAL_VOL_GUARANTEED_SETTING	99MNDRY	ml	1.3.2.C	Vent.	
Tpause	20007	MNDRY_VENT_PAUSE_TIME_PERCENT_SETTING	99MNDRY	%	1.3.2.C	Vent.	
PlimVG	20008	MNDRY_VENT_PRESS_LIMIT_VOL_GUARANTEE_SETTING	99MNDRY	cmH2O	1.3.2.C	Vent.	
ApneaTi	20009	MNDRY_VENT_APNEA_TIME_SETTING	99MNDRY	s	1.3.2.C	Vent.	
O2 Flow	20010	MDC_FLOW_O2_FG_SETTING	99MNDRY	l/min	1.3.3.C	Fresh Gas	EFCS (A7 Only)
N2O Flow	20011	MDC_FLOW_O2_FG_SETTING	99MNDRY	l/min	1.3.3.C	Fresh Gas	EFCS (A7 Only)
AIR Flow	20012	MDC_FLOW_O2_FG_SETTING	99MNDRY	l/min	1.3.3.C	Fresh Gas	EFCS (A7 Only)

NOTE: x.x.x.C - where C = OBX-3-1 for that parameter.

B.5 Ventilation Modes

Parameter	OBX-3-1 Code	OBX-3-2 RefID	OBX-3.3	OBX-5.1 Code	OBX-5.2 RefID	OBX-5.3	Unit of Measure	OBX-4	Module	Comment
Mode	184352	MDC_VENT_MODE	MDC				DimLess	1.3.1.C	Vent	HL7 CWE Type
Manual				50000	MNDRY_VENT_MODE_MANUAL	99MNDRY			Vent	
ACGO				50001	MNDRY_VENT_MODE_ACGO	99MNDRY			Vent	Auxiliary common gas outlet (A7 Only)
Manual + Alarms Off				50002	MNDRY_VENT_MODE_MANUAL_PLUS_ALM_OFF	99MNDRY			Vent	
Manual + Bypass				50003	MNDRY_VENT_MODE_MANUAL_PLUS_BYPASS	99MNDRY			Vent	(A3 and A5 Only)
Manual + Monitor				50004	MNDRY_VENT_MODE_MANUAL_PLUS_MONITOR	99MNDRY			Vent	With external AG module only
VCV				50005	MNDRY_VENT_MODE_VCV	99MNDRY			Vent	
PS				50006	MNDRY_VENT_MODE_PS	99MNDRY			Vent	
SIMV-VC				50007	MNDRY_VENT_MODE_SIMVC	99MNDRY			Vent	
SIMV-VC + PS				50008	MNDRY_VENT_MODE_SIMVC_PLUS_PS	99MNDRY			Vent	
SIMV-PC				50009	MNDRY_VENT_MODE_SIMVPC	99MNDRY			Vent	
SIMV-PC + PS				50010	MNDRY_VENT_MODE_SIMVPC_PLUS_PS	99MNDRY			Vent	
PCV				50011	MNDRY_VENT_MODE_PCV	99MNDRY			Vent	(A3 Only)
PCV + VG				50012	MNDRY_VENT_MODE_PCV_PLUS_VG	99MNDRY			Vent	(A3 and A5 Only)
AVNF				50013	MNDRY_MODE_AVNF	99MNDRY			Vent	Auto-Ventilation Non- Functional

NOTE: x.x.x.C - where C = OBX-3-1 for that parameter.

B.6 System Status

Parameter	OBX-3-1 Code	OBX-3-2 RefID	OBX-3.3	OBX-5.1 Code	OBX-5.2 RefID	OBX-5.3	Unit of Measure	OBX-4	Module	Comment
Device Status	202886	MDC_EVT_STAT_DEV	MDC				DimLess	1.1.1.C	System	HL7 CWE Type
Off				202834	MDC_EVT_STAT_OFF	MDC			System	Sent (if possible) during power down sequence
Running				202902	MDC_EVT_STAT_RUNNING	MDC			System	Sent when not in standby and not powering down
Standby/ Discharge				202836	MDC_EVT_STAT_STANDBY	MDC			System	Sent during standby only.
Device Mode	30002	MNDRY_EVT_STAT_MODE_DEV	99MNDRY				DimLess	1.1.1.C	System	HL7 CWE Type
Normal Mode				30003	MNDRY_EVT_STAT_MODE_NORMAL	99MNDRY			System	
Service Mode				202840	MDC_EVT_STAT_MODE_TEST	MDC			System	Sent when in service mode
Demo Mode				30004	MNDRY_EVT_STAT_MODE_DEMO	99MNDRY				Sent when in demo mode only
Patient Type	30005	MNDRY_EVT_PATIENT_TYPE	99MNDRY				DimLess	1.1.1.C	System	HL7 CWE Type
Adult				202890	MDC_EVT_STAT_DEV_MODE_ADULT	MDC			System	
Pediatric				202888	MDC_EVT_STAT_DEV_MODE_PEDIATRIC	MDC			System	
Infant				30006	MNDRY_EVT_STAT_DEV_MODE_INFANT	99MNDRY			System	
Warmer On	30007	MNDRY_EVT_STAT_WARMER_ON_BOOL	99MNDRY				DimLess	1.3.1.C	Warmer	HL7 CWE Type
True				30000	MDC_TRUE	99MNDRY			Warmer	
False				30001	MDC_FALSE	99MNDRY			Warmer	

NOTE: x.x.x.C - where C = OBX-3-1 for that parameter.

B.7 Patient Measurements

Parameter	OBX-3.1 Code	OBX-3.2 RefID	OBX-3.3	Unit of Measure	OBX-4	Module	Comment
Weight	188736	MDC_MASS_BODY_ACTUAL	MDC	kg	1.2.1.C	System	

NOTE: x.x.x.C - where C = OBX-3-1 for that parameter.

B.8 Ventilator / Anesthesia Machine Measurement IDs

Parameter	OBX-3.1 Code	OBX-3.2 RefID	OBX3-3	UoM	OBX-4	Module	Comment
I:E	151832	MDC_RATIO_IE	MDC	No UoM	1.3.2.C	Vent.	HL7 SN Type
Peak	151957	MDC_VENT_PRESS_MAX	MDC	cmH2O	1.3.2.C	Vent.	
Mean	151819	MDC_PRESS_AWAY_INSP_MEAN	MDC	cmH2O	1.3.2.C	Vent.	
Plat	151784	MDC_PRESS_RESP_PLAT	MDC	cmH2O	1.3.2.C	Vent.	
PEEP	151976	MDC_VENT_PRESS_AWAY_END_EXP_POS	MDC	cmH2O	1.3.2.C	Vent.	
MV	151880	MDC_VOL_MINUTE_AWAY	MDC	l/min	1.3.2.C	Vent.	
Vt	151868	MDC_VOL_AWAY_TIDAL	MDC	ml	1.3.2.C	Vent.	
Rate	151586	MDC_VENT_RESP_RATE	MDC	rpm	1.3.2.C	Vent.	
R	151840	MDC_RES_AWAY	MDC	cmH20/l/s	1.3.2.C	Vent.	
C	151688	MDC_COMPL_LUNG	MDC	ml/cmH20	1.3.2.C	Vent.	
O2 Flow	113	MDC_FLOW_O2_FG	99MNDRY	l/min	1.3.3.C	Fresh Gas	Measured fresh gas flow
N2O Flow	114	MDC_FLOW_N2O_FG	99MNDRY	l/min	1.3.3.C	Fresh Gas	Measured fresh gas flow
AIR Flow	115	MDC_FLOW_AIR_FG	99MNDRY	l/min	1.3.3.C	Fresh Gas	Measured fresh gas flow

NOTE: x.x.x.C - where C = OBX-3-1 for that parameter.

B.9 Airway Gas Analyzer Measurement IDs

Parameter	OBX-3.1 Code	OBX-3-2 RefID	OBX-3.3	UoM	OBX-4	Module	Comment
EtO2	152440	MDC_CONC_AWAY_O2_ET	MDC	%	1.4.1.C	AG	Exp O2
FiO2	152196	MDC_CONC_AWAY_O2_INSP	MDC	%	1.4.1.C	AG	FiO2 in A3/A5; Insp O2 in A7
EtCO2	151708	MDC_CONC_AWAY_CO2_ET	MDC	mmHg	1.4.1.C	AG	EtCO2
FiCO2	151716	MDC_CONC_AWAY_CO2_INSP	MDC	mmHg	1.4.1.C	AG	FiCO2
Rate	151594	MDC_CO2_RESP_RATE	MDC	rpm	1.4.1.C	AG	Resp Rate from CO2
EtN2O	152108	MDC_CONC_AWAY_N2O_ET	MDC	%	1.4.1.C	AG	Exp N2O
FiN2O	152192	MDC_CONC_AWAY_N2O_INSP	MDC	%	1.4.1.C	AG	Insp N2O
EtAA	152464	MDC_CONC_AWAY_AGENT_ET	MDC	%	1.4.1.C	AG	Exp Agent .
FiAA	152460	MDC_CONC_AWAY_AGENT_INSP	MDC	%	1.4.1.C	AG	Insp Agent
EtHal	152092	MDC_CONC_AWAY_HALOTH_ET	MDC	%	1.4.1.C	AG	Exp Hal .
FiHal	152176	MDC_CONC_AWAY_HALOTH_INSP	MDC	%	1.4.1.C	AG	Insp Hal
UsageHal	126	MDC_VOL_DELIV_HALOTH_LIQUID_CASE	99MNDRY	ml	1.4.1.C	AG	Cumulative Hal. Usage
EtEnf	152088	MDC_CONC_AWAY_ENFL_ET	MDC	%	1.4.1.C	AG	Exp Enf .
FiEnf	152172	MDC_CONC_AWAY_ENFL_INSP	MDC	%	1.4.1.C	AG	Insp Enf .
UsageEnf	127	MDC_VOL_DELIV_ENFL_LIQUID_CASE	99MNDRY	ml	1.4.1.C	AG	Cumulative Enf. Usage
EtIso	152100	MDC_CONC_AWAY_ISOFL_ET	MDC	%	1.4.1.C	AG	Exp Iso .
FiIso	152184	MDC_CONC_AWAY_ISOFL_INSP	MDC	%	1.4.1.C	AG	Insp Iso .
UsageIso	128	MDC_VOL_DELIV_ISOFL_LIQUID_CASE	99MNDRY	ml	1.4.1.C	AG	Cumulative Iso. Usage
EtSev	152096	MDC_CONC_AWAY_SEVOFL_ET	MDC	%	1.4.1.C	AG	Exp Sev .
FiSev	152180	MDC_CONC_AWAY_SEVOFL_INSP	MDC	%	1.4.1.C	AG	Insp Sev .
UsageSev	129	MDC_VOL_DELIV_SEVOFL_LIQUID_CASE	99MNDRY	ml	1.4.1.C	AG	Cumulative Sev. Usage
EtDes	152084	MDC_CONC_AWAY_DESFL_ET	MDC	%	1.4.1.C	AG	Exp Des .
FiDes	152168	MDC_CONC_AWAY_DESFL_INSP	MDC	%	1.4.1.C	AG	Insp Des .
UsageDes	130	MDC_VOL_DELIV_DESFL_LIQUID_CASE	99MNDRY	ml	1.4.1.C	AG	Cumulative Des. Usage
MAC	119	MDC_CONC_MAC	99MNDRY	DimLess	1.4.1.C	AG	MAC .

NOTE: x.x.x.C - where C = OBX-3-1 for that parameter.

FOR YOUR NOTES

C A Series HL7 Simulator Instructions

C.1 Overview

The A Series Simulator is designed as a demo tool based on Mindray A Series anesthesia systems, and it is mainly for the software developers and/or systems integrators that wish to communicate with Mindray A Series anesthesia systems that have software bundle version 02.02.00 or later.

Before using it, the user should install the **A Series Simulator** correctly in their PC or laptop first.

C.2 Simulator Setup

Right clicking the mouse on the simulator screen will open a dialog (see figure below), by which the user can see the available features and possible to change its configuration.



Device Setting

The Device Setting dialog will look like:

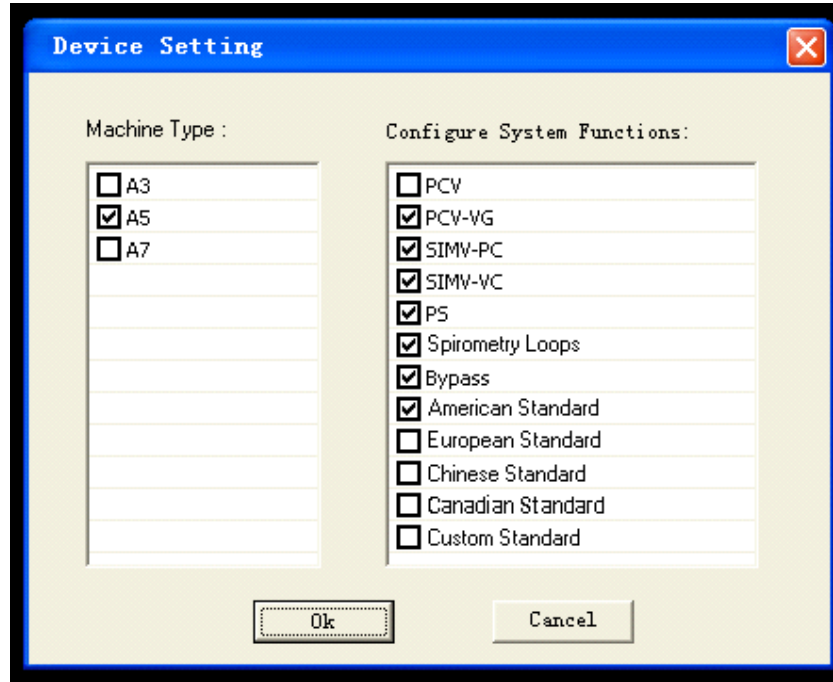

By device setting dialog, the user can change the machine type as well as configure the system functions. Any changes on Device Setting can only take effect after the simulator reboot.

About

The About dialog will look like:

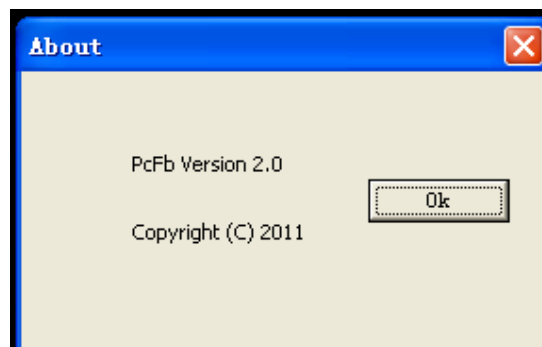

Exit

Click the **Exit** to exit the simulator.

C.3 Keyboard Shortcuts

For A3/A5/A7

- The user can switch the Auto/Manual state via the “m” key in keyboard.

For A3/A5 only

- The user can turn ON/OFF the fresh gas flow via the “f” key in keyboard.

FOR YOUR NOTES

Mindray DS USA, Inc. • 800 MacArthur Boulevard • Mahwah, NJ 07430 • USA •

Dom. Customer Service: 1.800.288.2121 • Intl. Customer Service: +1.201.995.8000 •

Dom. Fax: 1.800.926.4275 • Intl. Fax: +1.201.995.8680 • www.mindray.com

Mindray Medical Netherlands B.V. • Drs. W. van Royenstraat 8 • P.O. Box 26 • 3870
CA Hoevelaken • The Netherlands • Tel: +31 33 25 44 911 • Fax: +31 33 25 37 621

Mindray (UK) Limited • 3 Percy Road • St. John's Park • Huntingdon •
Cambridgeshire PE29 6SZ • United Kingdom • Tel: 01480 416840 • Fax: 01480
436588

Mindray Medical France SARL • Europarc Créteil • 123, Chemin des Bassins •
94035 Créteil Cedex • France • Tel: (0)1.45.13.91.50 • Fax: (0)1.45.13.91.51

Mindray Medical Germany GmbH • Zwischen den Bächen 4 • 64625 Bensheim •
Deutschland •

Tel: +49.6251.17524-0 • Fax: +49.6251.17524-20

Mindray Medical International Ltd. • 2813 Office Tower, Convention Plaza • No 1
Harbour Road Wanchai • Hong Kong • Tel: +852 2793 5596 • Fax: +852 2344 8824

Medstar Importação e Exportação Ltda • Av. Vereador José Diniz, 3300 • São Paulo,
SP • CEP 04804-000 • Brazil • Tel: 55 11 2872-3385 • Fax: 55 11 2872-3385

