

MINDRAY/ZONARE

Transducers Cleaning & Disinfection Guide



	<p>SHENZHEN MINDRAY BIO-MEDICAL ELECTRONICS CO., LTD. Mindray Building, Keji 12th Road South, High-Tech Industrial Park, Nanshan, Shenzhen, 518057, P.R.China</p>
	<p>Shanghai international Holding Corp. GmbH (Europe) Eiffestraße 80, 20537 Hamburg, Germany</p>

Technical Support

North America:

Phone support: 877-913-9663 or 650-316-3199 option 7 (ultrasound)

Email: techsupport@mindray.com

Sales support: 1-877-966-2731, salessupport@mindray.com

www.mindraynorthamerica.com

Europe and Asia:

Address: Mindray Building, Keji 12th Road South, High-tech industrial park, Nanshan, Shenzhen 518057, P.R.China

Website: www.mindray.com

E-mail: service@mindray.com

Tel: +86 755 81888998

Fax: +86 755 26582680

CAUTION: United States Federal law restricts this device to sale by or on the order of a licensed healthcare practitioner (USA).















For this Cleaning & Disinfection of Transducers manual, the issue date is 2020-02.

©2020 Shenzhen Mindray Bio-Medical Electronics Co., Ltd.

All rights reserved.



Symbols

Symbol	Definition or description
	Information that may relate to safety of the patient, the operator, or the equipment
	Waste Electrical & Electronic Equipment Standard. Meets the WEEE Standard. For more information, contact Technical Support.
	Refers to a type BF patient-applied part (B= body, F= floating applied part)
	Refers to a type CF patient-applied part (C= cardiac, F= floating applied part)
	Manufacturer
	Date of manufacture
	Consultation of Operator Manual Required
	Authorized Representative in the European Community
	Catalog Number of Item
	Shipping & Storage: Temperature Limits
	Shipping & Storage: Humidity limits
	Shipping & Storage: Pressure limits
Rx Only	Caution: Federal law restricts this device to sale by or on the order of a licensed healthcare practitioner (USA).
	Serial Number of Item
	This product is provided with a CE marking in accordance with the regulations stated in Council Directive 93 / 42 / EEC concerning Medical Devices. The number adjacent to the CE marking (0123) is the number of the EU-notified body certified for meeting the requirements of the Directive.

Intended Use

Transducers are intended for use with the Ultrasound Systems. Refer to the corresponding Ultrasound System Manual(s) for the Intended Use.

Cautions and Warnings

Refer to the corresponding Ultrasound System Manual(s) or Instructions for Use for a complete list of Warnings and Cautions associated with the use of the Transducers and Ultrasound System.



CAUTIONS

- Cleaners and disinfectants identified in this manual are recommended because of their chemical compatibility with product materials, as well as their biological efficacy (reduction in the number of microorganisms) or cleaning (removal of organic and inorganic material) on the transducers when using the instructions provided herein. It is important that these instructions are followed carefully to properly clean and disinfect the transducer. Always refer to the guidelines and recommendations of the disinfectant or cleaner manufacturer.
- Using a non-recommended cleaning or disinfectant solution, incorrect solution strength, or immersing the transducer deeper or longer than indicated can damage the transducer. Damages linked to the use of disapproved chemicals are not covered under product warranty or service contract.
- To prevent possible damage to the electronics of the transducer, never immerse the transducer beyond the point documented in **Table 1**. Additionally, use caution to avoid getting fluid on transducer connector electrical contact area. Do not use any cleaner or disinfectant on the connector electrical contacts.
- Do not use the carrying case for storing the transducer. If the carrying case is used for storage, it may become a source of infection.
- The transducer and accessories supplied with it are not delivered sterilized. Disinfection or sterilization before use is required.
- A legally marketed sterile transducer sheath and sterile gel must be installed over the transducer before performing intra-cavity, intraoperative or biopsy procedures. Protective barriers may be required to minimize disease transmission. Transducer sheaths are available for use with all clinical situations where infection is a concern.

To order transducer sheaths, contact:

CIVCO Medical Instruments Co.

Tel: 1-319-656-4447

E-mail: info@civco.com

<http://www.civco.com>

- When using a transducer sheath, be sure to cover the transducer with a new (unused) transducer sheath to prevent infection during examination. If the package of a transducer sheath is open or broken, the sterilization of the transducer sheath may not be sufficient. **DO NOT** use such a transducer sheath.
- **DO NOT** use an expired transducer sheath. Before using transducer sheaths, verify whether the term of validity has expired.
- The transducer sheath may contain natural rubber latex and talc that can cause allergic reactions in some individuals.

WARNINGS

- Always examine transducers for damage, such as cracks, splitting, holes, or fluid leaks. If damage is evident, discontinue use of the transducer and contact Technical Support.
- Prior to initiating any disinfection process, disconnect the transducer from the Ultrasound System.
- To avoid electrical shock prior to cleaning any device, turn off the system and unplug from AC power outlet. Do not allow disinfectant to contact metal surfaces. Always use protective eyewear and clothing when cleaning or disinfecting device.
- Disinfectant wipes and topical spray products are not FDA cleared high-level disinfectants and do not provide adequate protection should the transducer become cross-contaminated.

Cleaning, Disinfection and Sterilization Overview

Cleaning and disinfection refer to two distinct processes. According to the Centers for Disease Control and Prevention (CDC) "Guideline for Disinfection and Sterilization in Healthcare Facilities" (2008):

"Cleaning is the removal of visible soil (e.g. organic and inorganic material) from objects and surfaces and normally is accomplished manually or mechanically using water with detergents or enzymatic products. Thorough cleaning is essential before high-level disinfection and sterilization because inorganic and organic material that remains on the surfaces of instruments interfere with the effectiveness of these processes."

"Disinfection describes a process that eliminates many or all pathogenic microorganisms, except bacterial spores."

Low-Level Disinfection—Destruction of most bacteria, some viruses, and some fungi. Low-level disinfection will not necessarily inactivate *Mycobacterium tuberculosis* or bacterial spores.

High-Level Disinfection (HLD)—Destruction/removal of all microorganisms except bacterial spores.

"Sterilization describes a process that destroys or eliminates all forms of microbial life and is carried out in healthcare facilities by physical or chemical methods."

Selecting a Disinfection Method

Transducers can be divided into three categories based on their intended use. Some transducers may fall into more than one category (e.g. transducers use for biopsy procedures). When selecting a disinfectant, determine the required level of disinfection based on intended use and possibility of cross-contamination.

Contacts intact skin: Transducers that only come into contact with clean, intact skin are considered noncritical devices and require cleaning after every use. Cleaning may be followed by a low-level disinfectant spray or wipe.

Contacts mucous membranes: This category includes all endocavity transducers - intravaginal, transrectal, and transesophageal (TEE). These semi-critical transducers must be cleaned with an appropriate cleaner after use followed by high-level disinfection. Refer to H-046-011007-00 for instructions on cleaning and disinfecting TEE transducers.

Contacts otherwise sterile tissue or blood: These transducers are considered critical and include all intraoperative transducers. These transducers must be cleaned with an appropriate cleaner after each use, followed by a sterilization process. Refer to H-046-018758-00 for instruction on cleaning and sterilizing laparoscopic transducers.

Cleaning Disinfecting, or Sterilizing the Transducer

The following sections describe the approved methods to clean, disinfect, or sterilize transducers, except for TEE

transducers. Refer to H-046-011007-00 for instructions on cleaning and disinfecting TEE transducers, and H-046-018758-00 for instruction on cleaning and sterilizing laparoscopic transducer. The following figure depicts the components of an ultrasound transducer (non-TEE/non-laparoscopic).

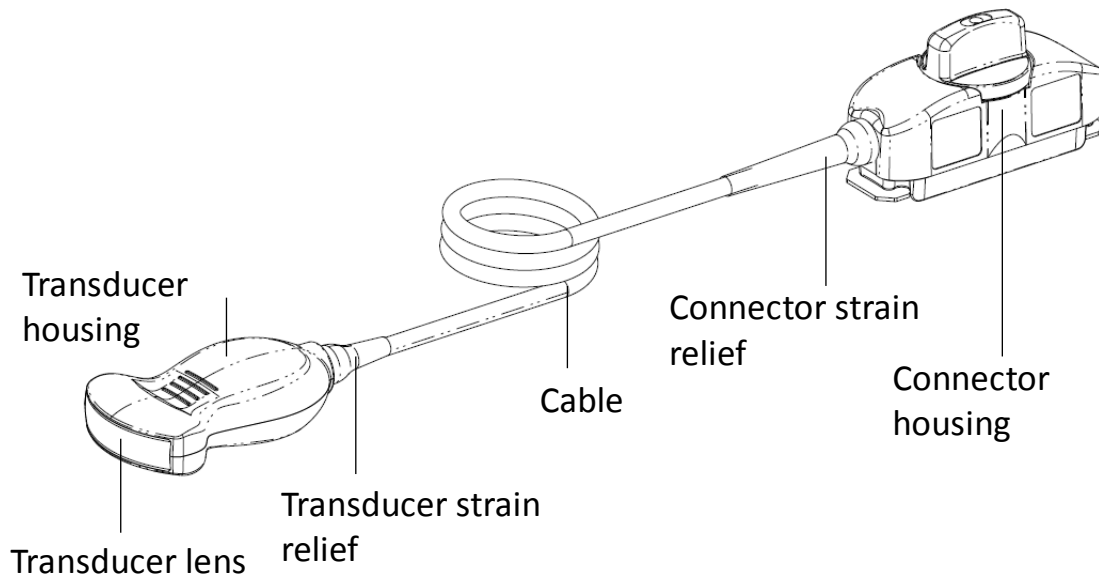

Cleaning Instructions



Transducers must be thoroughly cleaned after each use. Cleaning is a critical step to allow for effective disinfection.

Note: The instructions below should be used in conjunction with the cleaning agent manufacturer's instructions for use. These guidelines ensure the transducers are not damaged during the cleaning process and ensure effectiveness of the cleaning process.

1. Wear gloves to reduce contamination transfer and infection.
2. Except for wipe or spray cleaning, disconnect the transducer from the Cart or Scan Engine/Scan Module. If present, remove the transducer cover/sheath and discard.
3. Use a damp soft cloth to remove particulates, ultrasound coupling gel, or body fluids.
4. Choose an appropriate cleaning agent. Approved cleaners are listed in this document in **Table 2** and include cleaning wipes and sprays (listed as type disinfectant in **Table 2**), mild detergents, enzymatic cleaners and specially designed enzymatic sponges.
5. Follow the cleaning agent manufacturer's instructions for preparation and use of the cleaner. When cleaning the transducer, never allow any type of fluid to enter the connector strain relief or connector electrical contact area. Use one of the following methods:
 - Soaking: Soak the transducer in the cleaning fluid for a minimum of 1 minute or according to manufacturer instructions until the transducer is visibly clean. Light mechanical cleaning with a soft cloth may be necessary to remove dried on material or material trapped in seams or biopsy guide features.



To prevent possible damage to the electronics of the transducer, never immerse the transducer beyond the point documented in **Table 1**. Additionally, use caution to avoid getting fluid on the transducer connector electrical contact area. Do not use any cleaner or disinfectant on the connector electrical contacts

- Sponges: Use a pre-soaked enzymatic sponge product to wipe all surfaces of the transducer and transducer strain relief/cable if necessary for a minimum of 1 minute or according to manufacturer instructions until the transducer is visibly clean.
 - Wipes or Sprays: Use a transducer cleaning wipe product or soft cloth wetted with cleaning spray (in accordance with manufacturer instructions) and wipe all surfaces of the transducer and transducer strain relief/cable if necessary for a minimum of 1 minute or according to manufacturer instructions until the transducer is visibly clean.
6. Rinse thoroughly with room temperature tap water to remove remaining particulate and cleaning residue for 30 seconds. Alternatively for transducers that cannot be easily immersed, use a damp cloth to wipe surfaces of the transducer and cable until visibly clean.
 7. Air-dry (or towel dry) the transducer with a soft, clean cloth.
 8. Examine the transducer for damage, such as cracks, splitting, holes, or fluid leaks. If damage is evident, discontinue use of the transducer and contact Technical Support.

Disinfection Instructions

When choosing a disinfectant, determine the required level of disinfection based on intended use and possibility of cross-contamination. All semi-critical transducers require high-level disinfection before they can be used on another patient.

Warning: Disinfectant wipes and topical spray products are not FDA cleared high-level disinfectants and do not provide adequate protection should the transducer become cross-contaminated.

Note: The instructions below should be used in conjunction with the disinfectant agent manufacturer's instructions for use. These guidelines ensure that the transducers are not damaged during the disinfection process and ensure effectiveness of the disinfection process.

Low-level disinfection of non-critical transducers

Low level disinfection on non-critical transducers is achieved with appropriately labeled wipes and topical sprays. Biological effectiveness of these disinfectants has not been independently tested on the transducers. See guidelines and recommendations of the disinfectant manufacturer for use and efficacy information.

1. Wear gloves to reduce contamination transfer and infection.
2. Clean the transducer following the instructions in "Cleaning Instructions."
3. Choose an appropriate low-level disinfectant. Approved disinfectants (chemically compatible) are listed in this document in **Table 2** and include quaternary ammonium chlorides, ethylene glycols and hydrogen peroxides.
4. Follow the disinfectant agent manufacturer's instructions for preparation and use of the disinfectant.
5. Wipe or spray the transducer, strain relief, cable and connector housing with the disinfectant, following the manufacturer's instructions for duration of wipe/disinfectant contact to achieve desired results. Do not apply the disinfectant any longer than necessary. Do not allow any type of fluid to enter the connector strain relief or connector electrical contact area.
6. Allow the transducer to air-dry.
7. Examine the transducer for damage, such as cracks, splitting, holes, or fluid leaks. If damage is evident, discontinue use of the transducer and contact Technical Support.

High-level disinfection of semi-critical transducers

High level disinfection of semi-critical transducers is achieved with appropriately labeled HLD solutions and disinfectant systems. See guidelines and recommendations of the disinfectant manufacturer for appropriate use.

1. Wear gloves to reduce contamination transfer and infection.
2. Clean the transducer following the instructions in "Cleaning Instructions."
3. Choose an appropriate high-level disinfectant. Approved disinfectants are listed in this document in **Table 2** and include glutaraldehydes, hydrogen peroxides, and ortho-phthalaldehydes.
4. Follow the disinfectant agent manufacturer's instructions for preparation and use of the disinfectant or disinfectant system. When disinfecting the transducer, never allow any type of fluid to enter the connector strain relief or connector electrical contact area
5. If the transducer is to be immersed in a disinfection agent, never immerse the transducer beyond the point documented in **Table 1**. Also with immersion disinfectants, make sure to eliminate air pockets by vigorously swishing the transducer in the solution at the start.
6. After disinfection, follow the disinfectant manufacturer's instructions regarding rinsing with water and subsequent drying. Avoid prolonged exposure to water in regions of the transducer that cannot be immersed (refer to **Table 1**).
7. Follow manufacturer's instructions to dry the transducer.
8. Examine the transducer for damage, such as cracks, splitting, holes, or fluid leaks. If damage is evident, discontinue use of the transducer and contact Technical Support.

Sterilization of a critical probe

For intra-operative transducers, they have to be thoroughly cleaned and sterilized after completing each examination.

1. Wear a pair of gloves to prevent infection.
2. Clean the probe thoroughly in accordance with the cleaning procedure before sterilization.
3. Sterilize the probe by using an appropriate sterilant. Mindray recommended solutions to sterilize the probe are listed in **table 2**). For how to use the sterilant, see the operator's manual provided by the manufacturer. Prepare a sterilant by using sterile water when necessary.
 - Refer to the instructions provided by the chemical manufacturer concerning concentration of the sterilization solution, method of sterilization and dilution and cautions during use.
 - Do not soak the transducer connector or the cable near it into water or any solution.
 - Follow local regulations when selecting and using the sterilization solution.
4. Immerse the probe head partially in the sterilant and shake the probe appropriately to remove any bubbles on the probe surface. For details about the probe immersion duration, see the operator's manual provided by the manufacturer.
5. Rinse the probe thoroughly by using a large amount of sterile distilled water (about 2 gallons) at room temperature for about 30s to remove the residual sterilant. Repeat the operation twice. Or, follow the rinsing method recommended by the manufacturer of the sterilant to rinse the probe.
6. Dry the probe by wiping with a piece of sterile disposable lint-free soft cloth. Do not dry the probe by heating.
7. Check whether the probe has defects such as peeling, rifts, bumps, cracks, or liquid spill. If such defects exist, the probe has reached the end of its service life. In this case, stop using it and contact the Mindray service department.
8. Store the probe in a cool, clean and dry environment. And repeat the cleaning and sterilizing process before the next use.

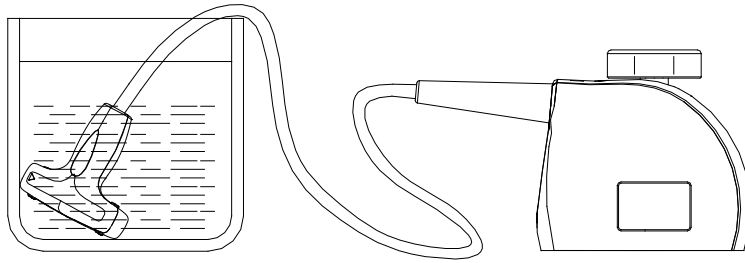

Immerse the intra-operative transducer in the solution (for reference)

⚠ CAUTION:

Repeated sterilization will eventually damage the transducer, please check the transducer's performance periodically.

TABLE 1: IMMERSION LIMITS FOR TRANSDUCERS

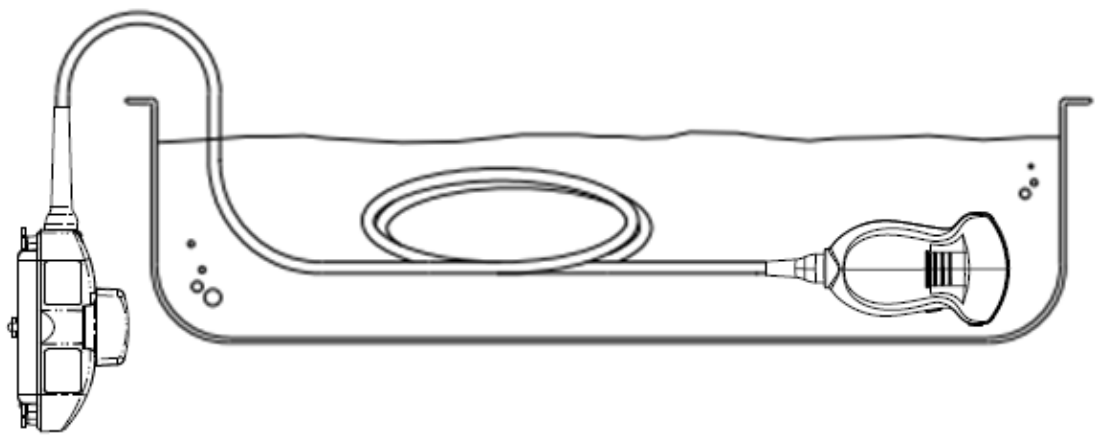
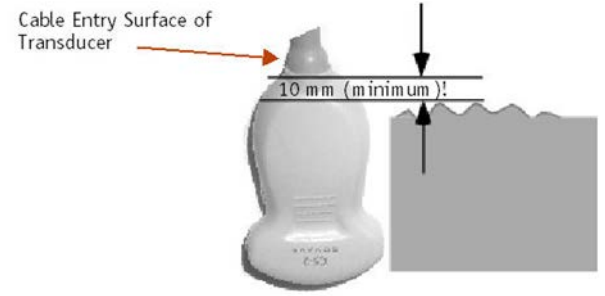
<p>Immersion Level Limit for the following transducers:</p> <p>A2CW A5CW C4-1 C6-1 C6-2 C8-3 3D C9-3 C9-3sp C10-3 C18-5 E9-3 E9-3 3D E9-4 L8-3 L10-5 L14-5sp L14-5w L20-5 P4-1c P7-3c L30-8</p>	
<p>Immersion Level Limit for the following transducers:</p> <p>C5-2 C9-4t L12-4v P10-4 P4-1</p>	

Cleaning & Sterilizing the Needle-Guided Bracket

NGB-022 Needle-Guided Bracket (metal) needs to be cleaned and sterilized.

Cleaning

Follow the cleaning instructions in the manual.

1. Wear a pair of gloves to prevent infection.
2. After use, immerse the needle-guided bracket in distilled water immediately to prevent dirt from drying. Wipe the entire surface of the needle-guided bracket by using a piece of disposable lint-free soft cloth to remove coarse dirt.
3. Prepare a cleaning solvent (enzymatic or neutral pH detergent, e.g., liquinox, MetriZyme) by using distilled or softened water in accordance with the operator's manual provided by the manufacturer.
4. Detach all the detachable parts of the needle-guided bracket and immerse the detached parts fully in the cleaning solvent for at least 1 minute or a period specified by the manufacturer.
5. Immerse the needle-guided bracket and all its parts fully in the cleaning solvent. Wipe and wash the surface and connecting parts of the needle-guided bracket gently by using a soft brush until no dirt is visible. Place the needle-guided bracket inside an ultrasonic cleaner and perform ultrasonic cleaning for 3–5 minutes.
6. Rinse the needle-guided bracket thoroughly by using a large amount of distilled or softened water (about 2 gallons) at room temperature for about 30s to remove the residual dirt and cleaning solvent. Repeat the operation twice.
7. Wipe away the water on the needle-guided bracket by using a piece of disposable lint-free soft cloth.
8. Inspect the needle-guided bracket. If visible dirt still exists, repeat the preceding steps to wash the bracket until it is all clean.
9. Check whether the needle-guided bracket has defects such as deformation and rusting. If such defects exist, the bracket has reached the end of its service life. In this case, stop using it and contact the Mindray service department.

Sterilization

High-pressure steam sterilization (High-pressure steam sterilization is preferred for the metal guided brackets)

1. Wear a pair of gloves to prevent infection.
2. Clean the needle-guided bracket thoroughly in accordance with the cleaning procedure before sterilization.
3. Package the needle-guided bracket in accordance with the sterilization requirements of surgical instrument using the sterilization wrap or pouch cleared by FDA.
4. Place the packaged needle-guided bracket inside a high-temperature steam sterilizer and perform sterilization. The sterilization parameters are 121°C and 30 minutes for a gravity displacement steam sterilizer.
5. Take out the sterilization package after sterilization and dry it in an oven at 60°C for 20–30 minutes.
6. Keep the sterilization package together with other sterilized surgical instruments in a sterile item storage area.
7. Check whether the needle-guided bracket has defects such as deformation and rusting before use. If such defects exist, the bracket has reached the end of its service life. In this case, stop using it and contact the Mindray service department.

<p>NOTE: 1. <u>Repeated sterilization may degrade the safety and performance of the needle-guided bracket. Please check the needle-guided bracket's performance periodically.</u></p>
--

2. Needle guided brackets are required to verified before each biopsy. If the verification fails, it indicates that the needle-guided brackets are out of service life. For details about needle guided bracket verification, refer to the corresponding Ultrasound System Manual.

Approved Transducer Disinfectant, Sterilant and Cleaning Agents

Table 2 Type Legend: D=Disinfectant, C=Cleaner, HLD=High Level Disinfectant, S=Sterilant, Y= approved, N = not approved, BLANK=Not Tested, not approved

	Sani-Cloth AF3 (gray) Sani-Cloth HB (aareen)	Sani-Cloth Plus (red)	Cavicide Liquid	CaviWipes/CaviWipes XL	Dispatch Towels	PI-Spray II	Protex Spray	Protex Ultra Wipes	Accel TB Wipes	Sono Ultrasound Wipes	MetriZyme Liquid and MetriSponge	Revital-Ox Enzymatic Detergent	Prolystica 2X Enzymatic	Endozime and Endozime Sponge	Liquinox	Metricide	Metricide 28	Cidex	Revital-Ox Resert HLD	Trophon EPR	Cidex OPA	Metricide OPA Plus
Type	D	D	D	D	D	D	D	D	D	D	C	C	C	C	C	HLD/S	HLD/S	HLD/S	HLD	HLD	HLD	HLD
A2CW		Y	Y	Y	Y*										Y							
A5CW		Y	Y	Y	Y*										Y							
C4-1	Y	Y	Y	Y	Y	Y	Y	Y	Y	Y	Y	Y	Y	Y	Y	Y	Y	Y	Y	N	Y	Y
C5-2		Y*	Y*	Y*	Y*											Y*	Y*	Y*			Y*	Y*
C6-1													Y	Y	Y						Y	Y
C6-2	Y	Y	Y	Y	Y	Y	Y	Y	Y	Y	Y	Y	Y	Y	Y	Y	Y	Y	Y	N	Y	Y
C8-3 3D		Y	Y	Y	Y*						Y		Y	Y	Y	Y*	Y*	Y*	Y		Y*	Y*
C9-3	Y	Y	Y	Y	Y	Y	Y	Y	Y	Y	Y	Y	Y	Y	Y	Y	Y	Y	Y	N	Y	Y
C9-3sp		N	Y	Y							Y	Y	Y	Y	Y	Y	Y	N	Y	Y	Y	Y
C9-4t	Y	Y	Y	Y	Y	Y	Y	Y	Y	Y	Y	Y	Y	Y	Y	Y	Y	Y	Y	N	Y	Y
C10-3	Y	Y	Y	Y	Y	Y	Y	Y	Y	Y	Y	Y	Y	Y	Y	Y	Y	Y	Y	N	Y	Y
C18-5													Y	Y	Y						Y	Y
E9-3/ E9-4		N	N	N							Y	Y	Y	Y	Y	Y	Y	Y	Y	Y	Y	Y
E9-3 3D		Y	Y	Y	Y*						Y		Y	Y	Y	Y*	Y*	Y*	Y		Y*	Y*
L8-3	Y	Y	Y	Y	Y	Y	Y	Y	Y	Y	Y	Y	Y	Y	Y	Y	Y	Y	Y	N	Y	Y
L10-5	Y	Y	Y	Y	Y	Y	Y	Y	Y	Y	Y	Y	Y	Y	Y	Y	Y	Y	Y	N	Y	Y
L12-4v		Y*	Y*	Y*	Y*																Y*	Y*
L14-5sp	Y	Y	Y	Y	Y	Y	Y	Y	Y	Y	Y	Y	Y	Y	Y	Y	Y	Y	Y	Y	Y	Y
L14-5w	Y	Y	Y	Y	Y	Y	Y	Y	Y	Y	Y	Y	Y	Y	Y	Y	Y	Y	Y	N	Y	Y
L20-5	Y	Y	Y	Y	Y	Y	Y	Y	Y	Y	Y	Y	Y	Y	Y	Y	Y	Y	Y	N	Y	Y
P4-1		Y*	Y*	Y*	Y*											Y*	Y*	Y*			Y*	Y*
P4-1c	Y	Y	Y	Y	Y	Y	Y	Y	Y	Y	Y	Y	Y	Y	Y	Y	Y	Y	Y	N	Y	Y
P10-4		Y*	Y*	Y*	Y*								Y*	Y*		Y*	Y*	Y*			Y*	Y*
P7-3c	Y	Y	Y	Y	Y	Y	Y	Y	Y	Y	Y	Y	Y	Y	Y	Y	Y	Y	Y	N	Y	Y

	Metricide OPA Plus	
	Cidex OPA	
	Trophon EPR	
	Revital-Ox Resert HLD	
	Cidex	Y*
	Metricide 28	
	Metricide	
	Liquinox	
	Endozime and Endozime Sponge	
	Prolystica 2X Enzymatic	
	Revital-Ox Enzymatic Detergent	
	MetriZyme Liquid and MetriSponge	
	Sono Ultrasound Wipes	
	Accel TB Wipes	
	Protex Ultra Wipes	
	Protex Spray	
	PI-Spray II	
	Dispatch Towels	
	CaviWipes/CaviWipes XL	
	Cavicide Liquid	
	Sani-Cloth Plus (red)	
	Sani-Cloth AF3 (gray) Sani-Cloth HB (green)	
L30-8		
P9-3ic	SINGLE USE ITEM, NOT DISINFECTIBLE	

* indicates 1 year equivalent use testing instead of normal 5 year.

FDA Cleared Solution/Device

- Cavicide Liquid
- Revital-Ox Resert HLD
- Accel TB Wipes
- Sani-Cloth AF3 (gray)
- CaviWipes
- Sani-Cloth Plus (red)
- Dispatch Towels
- Metricide 28
- Cidex OPA
- Metricide
- Cidex
- Trophon EPR



P/N: 046-010597-00 (7.0)