

Communication Protocol Interface Guide (DSP)

A-Series Anesthesia System

Table of Contents

1 Overview	1-1
1.1 Introduction	1-1
1.2 References	1-1
1.3 Physical Connections	1-2
1.3.1 Network Port	1-2
1.3.2 Serial Port.....	1-3
1.4 Interface Protocols	1-4
1.4.1 PCD DEC Profile: Communicate Device Data (PCD-01)	1-4
1.4.2 PCD DEC Profile: Report Alert (PCD-04).....	1-4
1.4.3 ITI CT Profile: Time Synchronization	1-4
1.5 Use Cases	1-5
1.6 Applicable Scope.....	1-6
2 Communication Protocol Layers	2-1
2.1 Introduction to the A-Series Export Protocol	2-1
2.1.1 Physical Layers	2-1
2.1.2 TCP Layer	2-2
3 System Setup.....	3-1
3.1 Anesthesia System Setup.....	3-1
3.1.1 Network Port Setup	3-2
3.1.2 Serial Protocol Setup.....	3-4
3.1.3 Demographics Setup	3-5
3.2 Time Synchronization Setup	3-7
4 Message Frame.....	4-1
4.1 RS-232 frame	4-1
4.2 Ethernet frame.....	4-1
5 A-Series Export Protocol	5-1
5.1 DEC Profile: Unsolicited Results.....	5-1
5.1.1 Supported Transmission Data.....	5-2
5.2 Message Details: Observation and Waveform Data	5-3
5.2.1 MSH Segment	5-4
5.2.2 PID Segment	5-5
5.2.3 PV1 Segment.....	5-6
5.2.4 Observation Block OBR Segment.....	5-6
5.2.5 Observation Block OBX Segment	5-8

5.2.6 Waveform Block OBR Segment	5-9
5.2.7 Waveform Block OBX Segment	5-9
5.3 Message Details: Alert Data.....	5-11
5.3.1 MSH Segment	5-12
5.3.2 PID Segment	5-12
5.3.3 PV1 Segment.....	5-12
5.3.4 Alert OBR Segment.....	5-12
5.3.5 Alert OBX Segment	5-13
6 Time Synchronization	6-1
6.1 CT (Consistent Time) Profile:.....	6-1
6.2 Introduction to the SNTP Protocol.....	6-2
6.2.1 UDP Layer.....	6-2
6.2.2 Packet Assembly	6-3
6.2.3 SNTP C/S Illustration.....	6-4
A CRC Calculation.....	A-1
A.1 Overview	A-1
A.2 CRC Calculation Guidance	A-1
B A-Series HL7 Export Nomenclature	B-1
B.1 General ID Allocation Scheme for “99MNDRY” Terms	B-1
B.2 A-Series - Anesthesia Machine Containment Tree	B-1
B.3 Units of Measure	B-2
B.4 Ventilator / Anesthesia Machine Settings IDs	B-3
B.5 Ventilation Modes.....	B-5
B.6 System Status.....	B-6
B.7 Patient Measurements.....	B-8
B.8 Ventilator / Anesthesia Machine Measurement IDs.....	B-8
B.9 Airway Gas Analyzer Measurement IDs	B-9
B.10 Waveform IDs.....	B-11
B.11 Alert IDs	B-11
C A-Series HL7 Simulator Instructions	C-1
C.1 Overview	C-1
C.2 Simulator Setup	C-1
C.3 Keyboard Shortcuts	C-2

1 Overview

1.1 Introduction

This guide is intended to be used by software developers and/or systems integrators that wish to communicate with Mindray A-Series anesthesia systems that have software bundle version 03.03.00. Future versions of firmware may support additional measurements, settings and/or modes.

The A-Series Anesthesia Systems can send out the Alert data, Observation data and Waveform data via Ethernet.

The A-Series Anesthesia Systems can send out the Alert data and Observation data via Serial Port

The A-Series Anesthesia Systems can communicate measurements and settings to other systems such as clinical IT systems. This is done using an HL7 based protocol based on the Integrating the Healthcare Enterprise (IHE) Patient Care Devices (PCD) Device to Enterprise Communication (DEC) profile. This document provides specifics on how the A-Series Anesthesia Systems implement this profile.

1.2 References

- HL7 V2.6
- IHE PCD Technical Framework Volume 1
- IHE PCD Technical Framework Volume 2
- IHE ITI Technical Framework Volume 1
- IHE ITI Technical Framework Volume 2
- IHE PCD Rosetta Terminology Profile
- ISO/IEEE 11073-10101 and 11073-10101a Nomenclature
- IETF RFC 2030 SNTP

1.3 Physical Connections

The A-Series anesthesia system can communicate via the Network Port and the Serial Port. Both ports can be used simultaneously.

1.3.1 Network Port

The A-Series anesthesia system can communicate using Ethernet. A standard 10/100 Base-T connector is located at the back of the machine for this purpose. Refer to the illustration below:

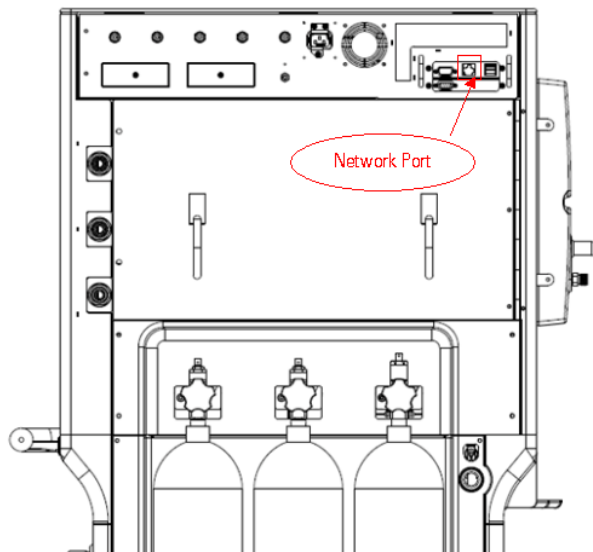

1.3.2 Serial Port

The A-Series anesthesia system can communicate using a Serial Port. A RS-232 asynchronous serial interface is located at the back of the machine for this purpose. Refer to the illustration below:

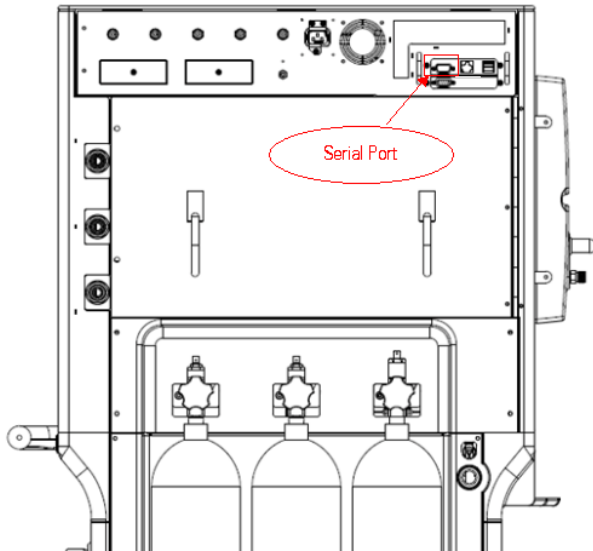

1.4 Interface Protocols

The messaging protocols used by the A-Series anesthesia systems are based on profiles established by the Integrating the Healthcare Enterprise (IHE) organization Patient Care Devices (PCD) and IT Infrastructure (ITI) domains. Two different IHE profiles are supported.

1.4.1 PCD DEC Profile: Communicate Device Data (PCD-01)

The A-Series uses the IHE PCD-01 transaction as a Device Observation Reporter (DOR) to transmit observation and settings data. This data is sent in an unsolicited manner at a maximum rate of a 10 second interval. Longer intervals are allowed by configuration. Continuous waveform data is also supported. The sending of waveform data can be enabled or disabled as needed. Waveforms are only supported over Ethernet.

1.4.2 PCD DEC Profile: Report Alert (PCD-04)

The A-Series supports the sending of alarm information in real time. The sending of alarms can be enabled or disabled as needed. The IHE PCD-04 transaction is used with the A-Series acting in the role of the Alarm Reporter (AR)

1.4.3 ITI CT Profile: Time Synchronization

The A-Series device supports the IHE Consistent Time (CT) Profile (ITI-01) only on the Ethernet port.

This profile supports the synchronization of time between a Time Server and a Time Client and is based on the IETF standard SNTP protocol. The Time Client periodically transmits synchronization request (using UDP) to the Time Server. The request interval as well as IP Address of the Time Server is configured on the Anesthesia System.

1.5 Use Cases

There are two general Use Cases that have been considered in development of the A-Series Interface Protocol:

1. Point-to-Point:

The interfacing of an A-Series Anesthesia System (DOR) directly to a local data consumer (DOC) such as a patient monitoring system or clinical information system. This scenario can be implemented via either the Serial Port (RS232) connection or the Network Port (Ethernet) using a point-to-point topology.

It is unlikely that the DOC will also support the Time Server functionality, so that any data collected by the DOC should be time-stamped by the DOC as of the time of receipt. In a point-to-point scenario, the DOC is also responsible for associating the data with the appropriate patient.

2. Networked:

The interfacing of an A-Series Anesthesia System over a network using the Network Port to a DOC which is typically a clinical IT system. In this case the network probably also has a network Time Server which the Anesthesia System can use to synchronize its clock.

In this situation it is also very important that the system end-user associate the device with the proper patient either through location or through entry of key patient demographics into the A-Series anesthesia system.

1.6 Applicable Scope

Currently, only the DEC and CT profiles are applicable to the A-Series anesthesia system.

2 Communication Protocol Layers

2.1 Introduction to the A-Series Export Protocol

The Export protocol used by the Mindray anesthesia systems is based on the technical framework specified by the IHE (Integrated Healthcare Enterprise) PCD (Patient Care Device) domain.

The syntax is based on HL7 and the semantic system used is based on ISO/IEEE 11073-10101 as documented in the IHE PCD Rosetta Profile to the extent that Reference IDs and codes are published for A-Series measurements and settings. If not available, then a Private code set has been used which will be substituted for Standards based sets when they are available.

While the HL7 protocol defines the syntax of a message it does not specify the framing (beginning and end) of a message. To mark the beginning and end boundaries of a message, the Minimal Lower Layer Protocol (MLLP, refer to HL7 Interface Standards Version 2.5.1) developed by the HL7 organization is used.

2.1.1 Physical Layers

2.1.1.1 RS-232 Physical Layer and Framing

The RS-232 port by default is configured to a 115200 Baud Rate, 8 Data bits, 1 Stop bit, Parity of none, and no flow control. The A-Series allows configuration of other settings with a minimum baud rate of 57600. The Data bits must always be 8-bits. Message error checking is done via a CRC mechanism.

MLLP is used to denote the beginning and end of the message. MLLP is the Minimal Lower Layer Protocol which is used by HL7 for delimiting the start and end of a message.

The structure of an MLLP message is:

<SB> + <Message> + <CRC> + <EB> + <CR>

Where:

<SB> = Start Block (0x0B (VT))

<Message> = Optimized IHE-PCD HL7 Message

<EB> = End Block (0x1C (FS))

<CR> = Carriage return (0x0D (CR))

<CRC> = 16 bit CRC in 4 ASCII characters (see Appendix A).

A 16-bit CRC checksum of the message content (not including the MLLP framing information (SB, EB, and CR)) is appended at the end of any message. For more information refer to Appendix A.

A typical message will look like:



2.1.1.2 Ethernet Framing

The Ethernet protocol has a built in CRC check so that each message does not need any application level checking for transmission errors. MLLP is used for message start and end delimiting on top of TCP/IP. MLLP is the Minimal Lower Layer Protocol which is used by HL7 for delimiting the start and end of a message.

The structure of an MLLP message is:

<SB> + <Message> + <EB> + <CR>

Where:

<SB> = Start Block (0x0B (VT))

<Message> = IHE-PCD compliant HL7 Message

<EB> = End Block (0x1C (FS))

<CR> = Carriage Return (0x0D (CR))

A typical message will look like:



2.1.2 TCP Layer

The Figure below shows the Network communication layers involved in the communication between Mindray anesthesia systems and communication partners.

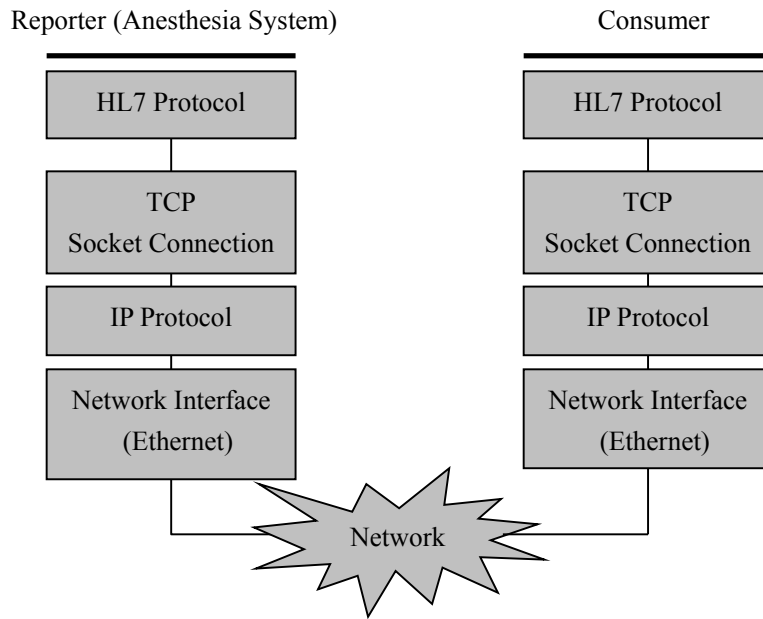

Communication Architecture (DEC Profile)

Corresponding to “TCP” layer in the Communication Architecture (DEC Profile).

- Connection-oriented Socket Service
- Use TCP/IP stack protocol
- Ethernet driver interface
- All networking information (IP, Port , Subnet, Gateway) is entered by the user manually

FOR YOUR NOTES

3 System Setup

3.1 Anesthesia System Setup

Before the anesthesia systems can communicate with a Data Consumer, the system must be properly configured as explained in this section. Please note that both the Serial port and the Network port can be used simultaneously, if desired, to connect to two different data consumers.

3.1.1 Network Port Setup

The technical user can enable the DOR function and configure the transmission frequency and server IP and port information via the user interface shown below (inside the red highlighted area). The A-Series Anesthesia Systems network port can only communicate with one DOC at a time (i.e. the device must be reconfigured to talk to a different DOC).

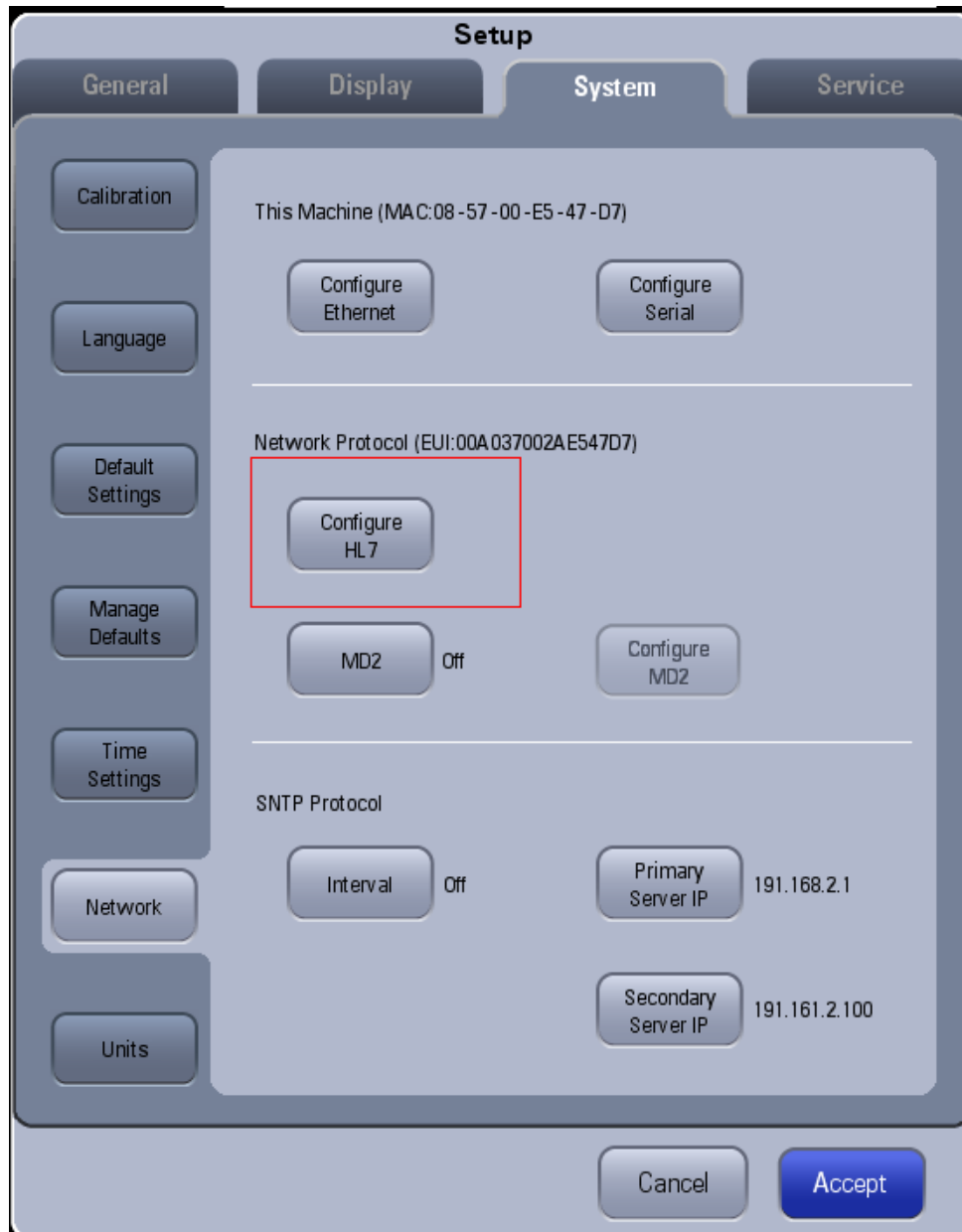

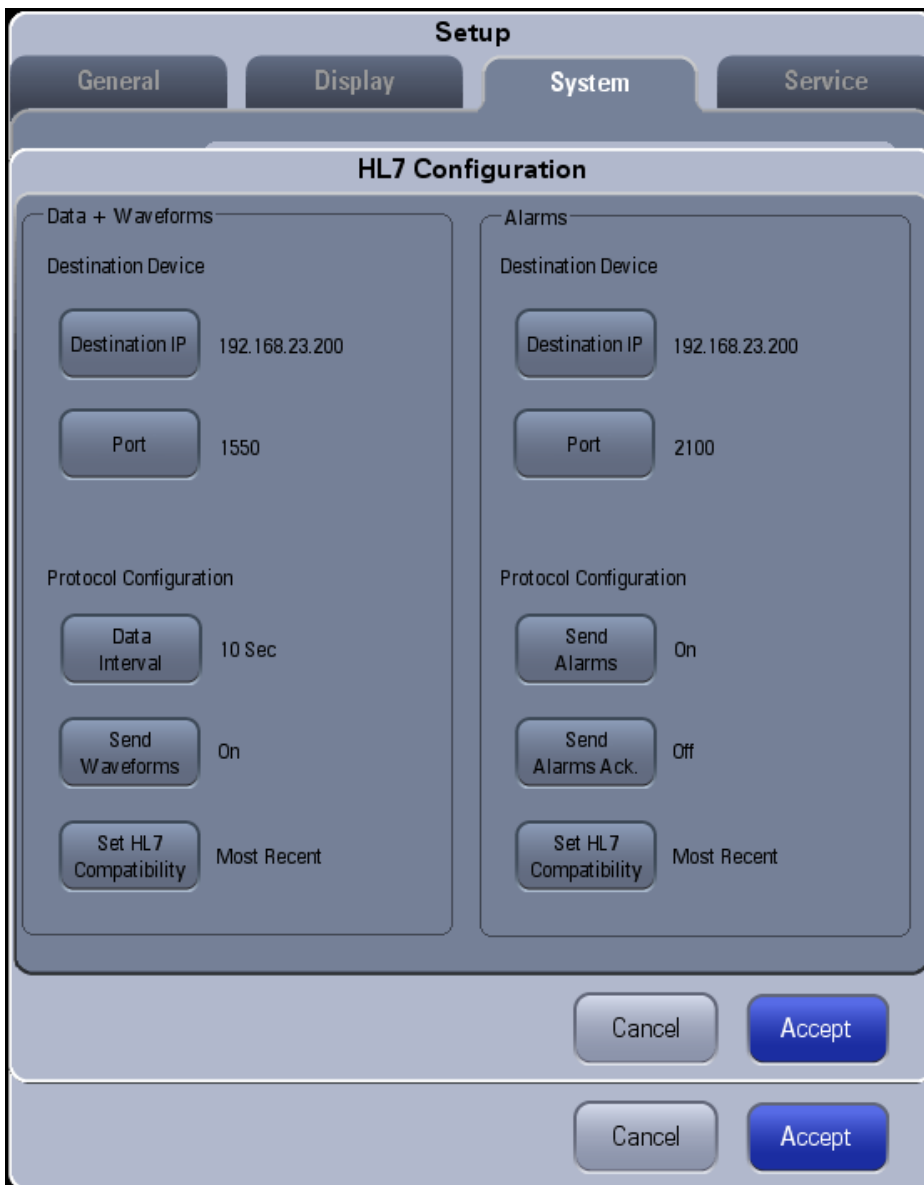

The Data reporting interval can be set to Off, 10 Sec, 30 Sec, 1 Min, 5 Min, 30 Min, 1 Hour, 2 Hour, 6 Hour, 12 Hour or 24 Hour.

The waveform data reporting interval is 500ms. The user can press the Send Waveforms button to configure whether to send out the waveforms data via HL7.

The user can press the Send Alarms button to configure whether to send out the alarm data via HL7.

The user can press the Send Alarm Ack. button to configure whether to send out the acknowledgement flag in the alarm message.

The user can press the Set HL7 Compatibility to select the right bundle version that your development is based on.

3.1.2 Serial Protocol Setup

The technical user can choose whether the serial port will communicate using the HL7 (MR-Link) protocol, the MR-WATO protocol or be turned off. The MR-WATO protocol is for Mindray internal use only.

When the Protocol selection is set to “None”, the DOR function using the serial port will be disabled.

When the Protocol selection is set to “HL7”, the user can configure the transmission frequency, Baud Rate, Stop bit (1 or 2) and Parity via the user interface shown below (Pushing the Configure Serial button to enter this dialog). No flow control and the Data bits must always be 8-bits. The A-Series Anesthesia System serial port can only communicate with one DOC at a time when the serial connection is established.

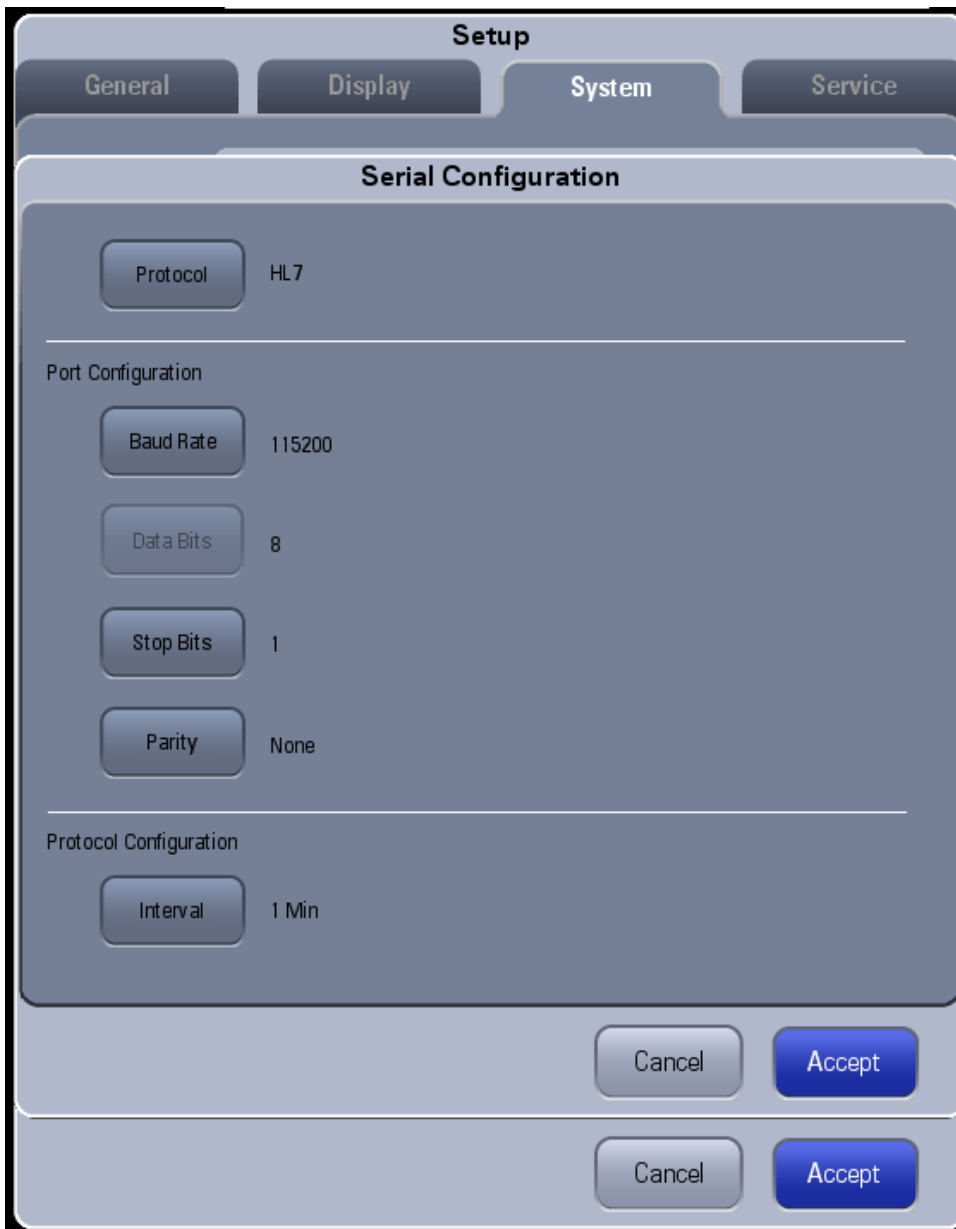

The message reporting interval can be set to 10 Sec, 30 Sec, 1 Min, 5 Min, 30 Min, 1 Hour, 2 Hour, 6 Hour, 12 Hour or 24 Hour.

3.1.3 Demographics Setup

The demographics information can be entered by user via the menu below. Patient ID, Visit Number, First Name, Last Name, DOB, and Weight are patient demographic data. Bed, Room, Point of Care and Facility are hospital demographic data. This demographic information will be transferred in the DEC profile message.

Waveforms	Spirometry	Demographics
Patient ID		Bed
3423		10
Visit Number		Room
4567		3A
First Name		Department
Mike		ICU
Last Name		Facility
Bill		NEWTOWN
DOB	Age	Weight (Lbs.)
1980/9/12	38	165.0

If the A-Series device is installed in a network topology, a minimum set of demographics data must be entered so that the receiving system can associate the device with the correct patient. Different receiving systems have different requirements. Note that the location data will not be deleted or changed unless the user changes it which should occur whenever the A-Series device changes location. Patient demographic data will be cleared whenever the patient is discharged.

3.2 Time Synchronization Setup

The A-Series anesthesia system is compliant with the SNTP protocol.

The technical user can set the synchronization frequency and server information corresponding to the role of CT Client information via the user interface shown below (inside the red highlighted area).

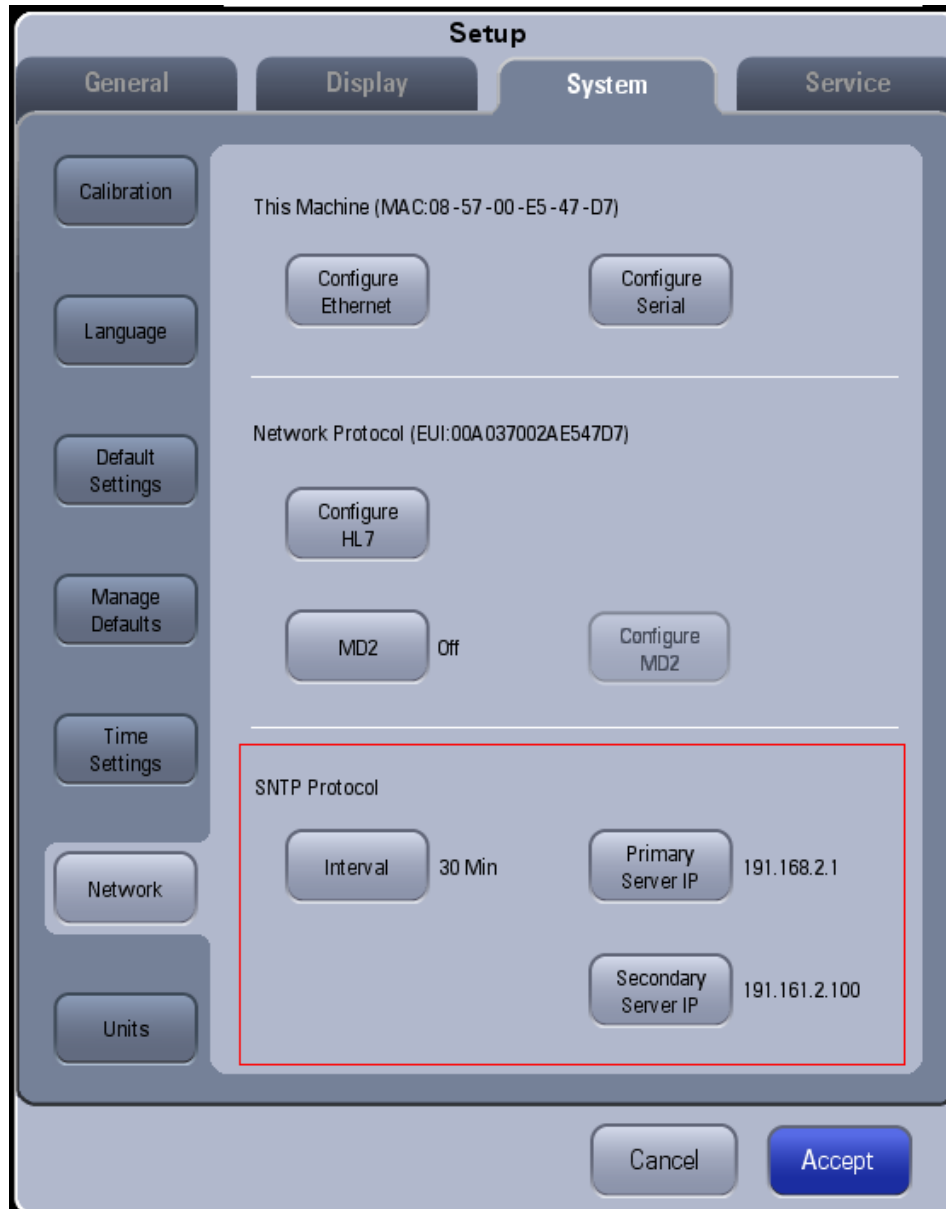

The technical user can configure the following:

- Interval: defines the time interval at which A-Series request the standard time periodically.
- Primary Server IP: defines the IP address of Primary Time Server.
- Secondary Server IP: defines the IP address of Secondary Time Server.

The time synchronize interval can be set to Off, 10 Sec, 30 Sec, 1 Min, 5 Min, 30 Min, 1 Hour, 2 Hour, 6 Hour, 12 Hour or 24 Hour.

Please note that if this function is set to “off” then the time-stamp requests sent to the time server by the Anesthesia System will stop and the CT profile will be disabled.

If the function is set to “on” and a Time Server is not available, the Anesthesia System will try to connect repeatedly according to the configured interval. If the connection attempt fails 5 times in a row, the Anesthesia System will display a “Could not locate time server” prompt message, this prompt message will be displayed until the connection attempt succeeds.

The Port of Time Server is fixed to 123.

UTC Time in System->Time Settings tab shall be used to calculate the time offset.

4 Message Frame

MLLP is the Minimal Lower Layer Protocol which is used by HL7 for delimiting the start and end of a message. And there are two kinds of message frame.

4.1 RS-232 frame

The frame of an MLLP message for RS-232 is:

<SB> + <Message> + <CRC> + <EB> + <CR>

Where:

<SB> = Start Block (0x0B (VT))

<Message> = Optimized IHE-PCD HL7 Message

<EB> = End Block (0x1C (FS))

<CR> = Carriage return (0x0D (CR))

<CRC> = 16 bit CRC in 4 ASCII characters (see Appendix A).

A 16-bit CRC checksum of the message content (not including the MLLP framing information (SB, EB, and CR)) is appended at the end of any message. For more information refer to Appendix A.

A typical message will look like:



4.2 Ethernet frame

The Ethernet protocol has a built in CRC check so that each message does not need any application level checking for transmission errors.

The frame of an MLLP message for Ethernet is:

<SB> + <Message> + <EB> + <CR>

Where:

<SB> = Start Block (0x0B (VT))

<Message> = IHE-PCD compliant HL7 Message

<EB> = End Block (0x1C (FS))

<CR> = Carriage Return (0x0D (CR))

A typical message will look like:



FOR YOUR NOTES

5 A-Series Export Protocol

5.1 DEC Profile: Unsolicited Results

The A-Series supports sending unsolicited results at a 10 second interval. Shorter or longer intervals are allowed by configuration. The Device Observation Reporter (DOR) (Mindray device) will continue to send unsolicited results at its configured interval independent of whether or not an ACK was received from the Device Observation Consumer (DOC). In Serial Port mode, the Ack (see Figure below) is not expected.

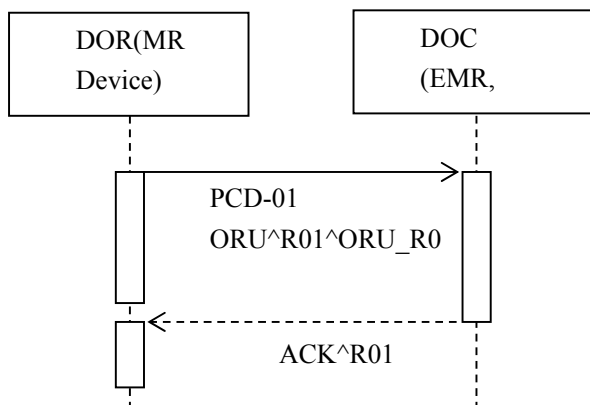

Unsolicited Results sequence Diagram

5.1.1 Supported Transmission Data

The Mindray anesthesia system acts in the role of a DOR in the IHE PCD DEC Profile architecture. It transmits the working data (measurements, settings, vent modes, status, etc.) periodically to the DOC (receiver). Please refer to Appendix B to get more details.

5.1.1.1 Notes

- In Standby mode, the A-Series anesthesia system does not send any ventilation information such as: ventilation mode, ventilation parameter measurements or settings.
- In ACGO mode, Manual mode or Auto Ventilation Non-Functional state ventilation parameter settings are not sent. ACGO mode is used on the A7 only.
- In Monitor mode, the A Series anesthesia system does not send fresh gas information.
- The A-Series anesthesia system will not send the parameters generated by an external or internal AG module unless they are connected. The external AG module is an optional configuration for the A5 and a standard configuration for the A7. The internal AG module is only on the A7.
- The actual agent measurements are only sent when the external AG module is connected and the system is not in Standby mode. The external AG module is an optional configuration for the A5 and a standard configuration for the A7.
- In all modes, all five of the cumulative agent usage values are sent when the internal AG module is connected. The internal AG module is only on the A7.
- The Rate that is measured by the ventilator(VCM) will be send. If the external AG module is connected, the Rate that is measured by AG Module will also be send.
- When the A-Series anesthesia system is in Auto Ventilation Non-Functional state, the measured parameters from the external AG module are still sent. The external AG module is an optional configuration for the A5 and a standard configuration for the A7.
- The A-Series anesthesia system will send out fresh gas flow setting parameters only when the EFCS is in use. EFCS is the Electronic Fresh Gas System used on A7 only. This is the standard method to control flow on the A7 anesthesia system. The desired flow is set by the user and proportional valves will achieve the set flow
- The A-Series anesthesia system will send out fresh gas flow measured parameters except when the BFCS is in use. BFCS is the backup fresh gas system used on the A7 only. This is the backup method to control flow on the anesthesia system. The flow cannot be preset to a particular value, the flow is increased or decreased by the user by turning mechanical valves.

5.2 Message Details: Observation and Waveform Data

This message is made up of a number of segments as follows:

- MSH Segment - Message Header
- PID Segment - Patient Identifier
- PV1 Segment - Patient Visit
- Observation Block OBR Segment - Observation Request
- Observation Block OBX Segment - Observation Results
- Waveform Block OBR Segment - Observation Request
- Waveform Block OBX Segment - Observation Results

Table 1 Data Message Structure

Segment	Meaning	Usage	Cardinality
MSH	Message Header	R	[1..1]
{	--- PATIENT RESULT begin	R	[1..1]
[--- PATIENT begin		
PID	Patient Identification	R	[1..1]
[--- VISIT begin		
PV1	Patient Visit	R	[1..1]
]	--- VISIT end		
]	--- PATIENT end		
{	--- ORDER_OBSERVATION begin	R	[0..1]
OBR	Observation Request	R	[1..1]
{	--- OBSERVATION begin	R	[1..N]
OBX	Observation Result	R	[1..1]
}	--- OBSERVATION end		
OBR	Wave Observation Request	R	[0..1]
{	--- WAVE OBSERVATION begin	R	[1..N]
OBX	Waveform Observation Result	R	[1..1]
}	--- WAVE OBSERVATION end		
}	--- ORDER_OBSERVATION end		
}	--- PATIENT RESULT end		

5.2.1 MSH Segment

The MSH segment defines the intent, source, destination, and some specifics of the syntax of a message.

MSH Segment definition:

Field	Name	Mindray Usage	
MSH-1	Field Separator	R	“ ”
MSH-2	Encoding Characters	R	“^~\&”
MSH-3	Sending Application	R	
MSH-3.1	Namespace ID	R	See Table 2 for values
MSH-3.2	Universal ID	R	“00A037” + 4 digit MR device ID + last six digits of serial number in Hex See Table 2 MR device ID values
MSH-3.3	Universal ID Type	R	“EUI-64”
MSH-4	Sending Facility	RE	Facility entered on the device
MSH-5	Receiving Application	X	EMPTY
MSH-6	Receiving Facility	X	EMPTY
MSH-7	Date/Time of Message	R	YYYY[MM[DD[HH[MM[SS.mmm]]]]] [+/-ZZZZ]
MSH-9	Message Type	R	
MSH-9.1	Message Code	R	”ORU”
MSH-9.2	Trigger Event	R	”R01”
MSH-9.3	Message Structure	R	”ORU_R01”
MSH-10	Message Control Id	R	An integer that is unique to each message.
MSH-11	Processing Id	R	
MSH-11.1	Processing ID	R	“P”
MSH-11.2	Processing Mode	X	EMPTY
MSH-12	Version ID	R	“2.6”
MSH-13	Sequence Number	X	EMPTY
MSH-14	Continuation Pointer	X	EMPTY
MSH-15	Accept Acknowledgment Type	R	“AL”
MSH-16	Application Acknowledgment Type	R	“NE”
MSH-17	Country Code	X	EMPTY
MSH-18	Character Set	RE	“UNICODE UTF-8”
MSH-19	Principal Language Of Message	X	EMPTY

Field	Name	Mindray Usage	
MSH-20	Alternate Character Set Handling Scheme	X	EMPTY
MSH-21	Message Profile Identifier	R	
MSH-21.1	Entity Identifier	R	"IHE_PCD_001"
MSH-21.2	Namespace ID	RE	"IHE PCD"
MSH-21.3	Universal ID	RE	"1.3.6.1.4.1.19376.1.6.1.1.1"
MSH-21.4	Universal ID Type	RE	"ISO"

Note: Fields that are not used are omitted for brevity.

Table 2 MSH-3 Sending Application Components

Device	4 Digit MR device ID	MSH-3.1
A3	0028	MINDRAY_A3
A5	0029	MINDRAY_A5
A7	002A	MINDRAY_A7
A4	002C	MINDRAY_A4

5.2.2 PID Segment

The PID segment is used as the primary means of communicating patient identification information. This segment contains permanent patient identifying and demographic information that, for the most part, is not likely to change frequently.

PID Segment Definition:

Field	Name	Mindray Usage	
PID-3	Patient Identifier List	R	
PID-3.1	ID Number	R	Patient ID entered
PID-3.4	Assigning Authority	R	Facility entered, or filled in with "Hospital" when Facility is empty
PID-3.5	Identifier Type Code	R	"PI"
PID-3.6	Assigning Facility	X	EMPTY
PID-5	Patient Name	O	
PID-5.1	Family Name	O	Last Name entered on the device
PID-5.2	Given Name	O	First Name entered on the device
PID-5.3	Second and Further Given Names	X	EMPTY
PID-5.4	Suffix	X	EMPTY
PID-5.5	Prefix	X	EMPTY
PID-5.7	Name Type Code	R	"L"

Field	Name	Mindray Usage	
PID-5.8	Name Representation Code	X	EMPTY
PID-6	Mother's Maiden Name	X	EMPTY
PID-7	Date/Time of Birth	RE	DOB entered on the device (YYYY[MM[DD]])
PID-8	Administrative Sex	RE	See Table 3 below

Table 3 Administrative Sex Value

Value	Gender
<blank>	Unspecified
M	Male
F	Female
U	Unknown

Note: Fields that are not used are omitted for brevity.

5.2.3 PV1 Segment

The PV1 segment is used to communicate information on an account or visit-specific basis.

PV1 Segment Definition:

Field	Name	Mindray Usage	
PV1-2	Patient Class	R	"I"
PV1-3	Assigned Location	RE	
PV1-3.1	Point of Care	RE	Point of Care entered on the device
PV1-3.2	Room	RE	Room entered on the device
PV1-3.3	Bed	RE	Bed entered on the device
PV1-3.4	Facility	RE	Facility entered on the device
PV1-19	Visit Number	RE	Visit Number entered on the device

Note: Fields that are not used are omitted for brevity.

5.2.4 Observation Block OBR Segment

The OBR segment is used to transmit a date and time of the OBX segments which follow.

OBR Segment Definition:

Field	Name	Mindray Usage	
OBR-1	Set ID OBR	R	An integer that is incremented for each OBR in the message.
OBR-2	Placer Order Number	R	

Field	Name	Mindray Usage	
OBR-2.1	Entity identifier	R	Same as MSH-10
OBR-2.2	Namespace ID	R	Same as MSH-3.1
OBR-2.3	Universal ID	R	Same as MSH-3.2
OBR-2.4	Universal ID Type	R	"EUI-64"
OBR-3	Filler Order Number	R	
OBR-3.1	Entity identifier	R	Same as OBR-2.1
OBR-3.2	Namespace ID	R	Same as OBR-2.2
OBR-3.3	Universal ID	R	Same as OBR-2.3
OBR-3.4	Universal ID Type	R	"EUI-64"
OBR-4	Universal Service Identifier	R	
OBR-4.1	Identifier	R	"182777000"
OBR-4.2	Text	R	"monitoring of patient"
OBR-4.3	Naming of Coding System	RE	"SCT"
OBR-7	Observation Date/Time	RE	YYYY[MM[DD[HH[MM[SS.mmm]]]]] [+/-ZZZZ]

Note: Fields that are not used are omitted for brevity.

5.2.5 Observation Block OBX Segment

The OBX segment is used to transmit a single observation or observation fragment. It represents the smallest indivisible unit of a report.

OBX Segment Definition:

Field	Name	Mindray Usage	
OBX-1	Set ID-OBX	R	An integer that is incremented for each OBX in the OBR block, starting at 1
OBX-2	Value Type	CE	“SN”, “NM”, “ST” or “CNE
OBX-3	Observation Identifier	R	
OBX-3.1	Identifier	R	Nomenclature Code
OBX-3.2	Text	R	Reference ID
OBX-3.3	Name of Coding System	R	“MDC” or “99MNDRY”
OBX-3.4	Alternate Identifier	X	EMPTY
OBX-3.5	Alternate Text	X	EMPTY
OBX-3.6	Name of Alternate Coding System	X	EMPTY
OBX-4	Observation Sub-ID	R	Refer to Appendix
OBX-5	Observation Value	CE	Correct Value
OBX-6	Units	CE	See Table 14 for values
OBX-7	Reference Range	X	EMPTY
OBX-8	Abnormal Flags	CE	”INV” if invalid “DEMO” if demo data
OBX-11	Observation Result Status	R	“R” or “F” or “X”
OBX-14	Date/Time of the Observation	RE	YYYY[MM[DD[HH[MM[SS.mmm]]]]] [+/-ZZZZ] If empty, the time of the observation is the time in the OBR-7 field.
OBX-18	Equipment Instance Identifier	RE	This field is only populated for the first OBX in the OBR block.
OBX-18.1		R	The EUI-64 value. See MSH-3.2 for how this value is defined.
OBX-18.2		X	EMPTY
OBX-18.3		R	The EUI-64 value. See MSH-3.2 for how this value is defined.
OBX-18.4		R	"EUI-64"
OBX-19	Data/Time of Analysis	CR	EMPTY
OBX-20	Observation Site	RE	Observation site of a value

Note: Fields that are not used are omitted for brevity.

Please Note:

The OBX-11 field will be filled in with 'R' for unconfirmed observations. These are observations that are machine measured and not confirmed by a clinician. Values confirmed by a clinician will be filled in with an 'F'. An example of this would be weight since it is entered by the clinician.

When sending an invalid value, the A-Series will set the OBX-2 "Observation Type" and OBX-5 "Observation Value" blank, OBX-8 to "INV", and OBX-11 to "X".

The OBX-2 field shall be populated using the values found in the table below. It is used to identify the data type of the OBX-5 field.

Value	HL7 Data Type	Observation Type
NM	Numerical Value	Integer Value Decimal Value
ST	String Value	String Value
SN	Structured Numeric	Ratios
CNE	Coded, No Exceptions	Enumerations
<Blank>	N/A	Any Invalid Value

5.2.6 Waveform Block OBR Segment

The Waveform Block OBR segment is used to transmit a date and time of the Waveform Block OBX segments which follow.

Waveform Block OBR Segment Definition:

Field	Name	Mindray Usage	
OBR-1	Set ID OBR	R	An integer that is incremented for each OBR in the message.
OBR-2	Placer Order Number	C	EMPTY
OBR-3	Filler Order Number	R	
OBR-3.1	Entity identifier	R	Same as MSH-10
OBR-3.2	Namespace ID	R	Same as MSH-3.1
OBR-3.3	Universal ID	R	Same as MSH-3.2
OBR-3.4	Universal ID Type	R	"EUI-64"
OBR-4	Universal Service Identifier	R	"CONTINUOUS WAVEFORM"
OBR-7	Observation Date/Time Start Time	R	YYYY[MM][DD][HH[MM[SS.mmm]]]] [+/-ZZZZ]
OBR-8	Observation Date/Time End Time	R	YYYY[MM][DD][HH[MM[SS.mmm]]]] [+/-ZZZZ]

5.2.7 Waveform Block OBX Segment

5.2.7.1 Notes on the OBX-4 Sub-ID

OBX-4 for the waveform data OBX segment follows the standard IHE format of M.V.C.I, where M = System, V = Virtual Device, C = Channel, I = Metric. I is set to the OBX-3.1 value for the

parameter. The following OBXs in the message that contain specifications for the waveform data follow the format of M.V.C.I.F, where F is an incrementing integer for each new OBX. The M.V.C.I component is identical to the value in the waveform data OBX. This allows the specifications to be associated with the waveform data OBX.

5.2.7.2 Waveform OBX segment, Waveform Data

This OBX specifies the data samples for the waveform.

Field	Name	Mindray Usage	
OBX-1	Set ID-OBX	R	An integer that is incremented for each OBX in the OBR block, starting at 1
OBX-2	Value Type	R	“NA”
OBX-3	Observation Identifier	R	The code for the waveform. See Table 20 for values.
OBX-4	Observation Sub-ID	R	The containment value. See section 5.2.7.1 for details.
OBX-5	Observation Value	R	Correct Value
OBX-6	Units	R	“262656^MDC_DIM_DIMLESS^MDC”
OBX-20	Observation Site	RE	Observation site of the waveform

5.2.7.3 Waveform OBX segment, Waveform Sample Rate

This OBX specifies the sample rate for the waveform.

Field	Name	Mindray Usage	
OBX-1	Set ID-OBX	R	An integer that is incremented for each OBX in the OBR block, starting at 1
OBX-2	Value Type	R	“NM”
OBX-3	Observation Identifier	R	“0^MDC_ATTR_SAMP_RATE^MDC”
OBX-4	Observation Sub-ID	R	The containment value. See section 5.2.7.1 for details.
OBX-5	Observation Value	R	The sample rate of the waveform
OBX-6	Units	R	“264608^MDC_DIM_PER_SEC^MDC”

5.2.7.4 Waveform OBX segment, Waveform Resolution

This OBX specifies the resolution for the waveform.

Field	Name	Mindray Usage	
OBX-1	Set ID-OBX	R	An integer that is incremented for each OBX in the OBR block, starting at 1
OBX-2	Value Type	R	“NM”
OBX-3	Observation Identifier	R	“2327^MDC_ATTR_NU_MSMT_RES^MDC”
OBX-4	Observation Sub-ID	R	The containment value. See section 5.2.7.1 for details.
OBX-5	Observation Value	R	The data resolution
OBX-6	Units	R	The units of measure for the waveform data. See Table 14 for values.

The value of the waveform sample is multiplied by the data resolution (OBX-5) to compute the waveform value in the units specified (OBX-6).

5.2.7.5 Waveform OBX segment, Invalid Value

This OBX specifies the value in the waveform data that indicates an invalid value. This segment is optional if the waveform does not contain an invalid value.

Field	Name	Mindray Usage	
OBX-1	Set ID-OBX	R	An integer that is incremented for each OBX in the OBR block, starting at 1
OBX-2	Value Type	R	“NM”
OBX-3	Observation Identifier	R	“262196^MDC_EVT_INOP^MDC”
OBX-4	Observation Sub-ID	R	The containment value. See section 5.2.7.1 for details.
OBX-5	Observation Value	R	The waveform data sample value that flags an invalid value in the waveform data.

5.2.7.6 Waveform OBX segment, Event

This OBX specifies an event in the waveform data. This segment is optional if the waveform segment does not contain any events. Multiple events can be sent within a single waveform segment.

Field	Name	Mindray Usage	
OBX-1	Set ID-OBX	R	An integer that is incremented for each OBX in the OBR block, starting at 1
OBX-2	Value Type	R	“CWE”
OBX-3	Observation Identifier	R	“0^MDC_ATTR_EVENT^MDC”
OBX-4	Observation Sub-ID	R	The containment value. See section 5.2.7.1 for details.
OBX-5	Observation Value	R	The code representing the event type. See Table 4 for values.
OBX-14	Observation Date/Time	RE	YYYY[MM[DD[HH[MM[SS.mmm]]]]] [+/-ZZZZ]

Table 4 Waveform Event Codes

Event	Value		
	Code	Text	Coding System
Start of Spontaneous Breath	30903	MNDRY_EVT_SPONT_BREATH_START	99MNDRY
End of Spontaneous Breath	30904	MNDRY_EVT_SPONT_BREATH_END	99MNDRY

5.3 Message Details: Alert Data

The Alert message is used to transmit alert information from the A-Series.

Table 5 Alert Message Structure

Segment	Meaning	Usage	Cardinality
MSH	Message Header	R	[1..1]
{	--- ALERT_begin	R	[1..1]

Segment	Meaning	Usage	Cardinality
[--- PATIENT begin		
PID	Patient Identification	R	[1..1]
[--- LOCATION begin		
PV1	Alert Location	R	[1..1]
]	--- LOCATION end		
]	--- PATIENT end		
{	--- ALERT_IDENTIFICATION begin		[1..1]
OBR	Alert Identification	R	[1..1]
{	--- ALERT_OBSERVATION begin	R	[1..7]
OBX	Alert specification	R	[1..1]
}	--- ALERT OBSERVATION end		
}	--- ALERT_IDENTIFICATION end		
}	--- ALERT end		

5.3.1 MSH Segment

Unless otherwise specified this message follows MSH segment definition defined in section 5.2.1 MSH Segment.

5.3.1.1 MSH-9 Message Type

MSH-9 will be populated with “ORU^R40^ORU_R40” in an Alert Message.

5.3.1.2 MSH-21 Message Profile Identifier

MSH-21 will be populated with “IHE_PCD_ACM_001^IHE_PCD^1.3.6.1.4.1.19376.1.6.1.4.1^ISO” in an Alert Message.

5.3.2 PID Segment

This message follows the PID segment definition defined in 5.2.2 PID Segment.

5.3.3 PV1 Segment

This message follows the PV1 segment definition defined in 5.2.3 PV1 Segment. PV1-2 shall be populated with an “I”.

5.3.4 Alert OBR Segment

The Alert Data Block OBR segment is used to transmit a date and time of the Alert OBR Block OBX segments which follow.

Alert OBR Segment Definition:

Field	Name	Mindray Usage	
OBR-1	Set ID OBR	R	An integer that is incremented for each OBR in the message.
OBR-2	Placer Order Number	X	EMPTY
OBR-3	Filler Order Number	R	
OBR-3.1	Entity identifier	R	Same as MSH-10
OBR-3.2	Namespace ID	R	Same as MSH-3.1
OBR-3.3	Universal ID	R	Same as MSH-3.2
OBR-3.4	Universal ID Type	R	Same as MSH-3.3
OBR-4	Universal Service Identifier	R	“196616^MDC_EVT_ALARM^MDC”
OBR-7	Observation Date/Time	RE	The time that the alert message was prepared to be sent. (YYYY[MM[DD[HH[MM[SS.mmm]]]]) [+/-ZZZZ])
OBR-29	Parent	R	The code will be empty if the alarm starts
OBR-29.2.1	Entity identifier	R	A unique integer ID for the alert. All messages related to the same alert will have the same unique ID.
OBR-29.2.2	Namespace ID	R	Same as MSH-3.1
OBR-29.2.3	Universal ID	R	Same as MSH-3.2
OBR-29.2.4	Universal ID Type	R	Same as MSH-3.3

5.3.5 Alert OBX Segment

5.3.5.1 Alert OBX segment, Facet 1 Event Identification

This OBX specifies the alert event type.

Field	Name	Mindray Usage	
OBX-1	Set ID-OBX	R	An integer that is incremented for each OBX in the OBR block, starting at 1
OBX-2	Value Type	R	“CWE”
OBX-3	Observation Identifier	R	“196616^MDC_EVT_ALARM^MDC”
OBX-4	Observation Sub-ID	R	The containment value of the alert appended with “.1”. Refer to Appendix B for containment values.
OBX-5	Observation Value	R	See Note 1
OBX-11	Observation Result Status	R	“F”
OBX-14	Observation Date/Time	RE	YYYY[MM[DD[HH[MM[SS.mmm]]]]) [+/-ZZZZ]

Note 1:

- OBX-5 shall be populated with values from Table 22 Non-Threshold Alerts for non-threshold alarms.
- OBX-5 shall be populated with “196652^MDC_EVT_HI_VAL_GT_LIM^MDC” for a high threshold alarm.
- OBX-5 shall be populated with “196674^MDC_EVT_LO_VAL_LT_LIM^MDC” for a low threshold alarm

5.3.5.2 Alert OBX segment, Facet 2 Source Identification

This OBX specifies the source of the alert event. It follows two formats based on the type of alarm specified in Facet 1.

Threshold Alarms

Field	Name	Mindray Usage	
OBX-1	Set ID-OBX	R	An integer that is incremented for each OBX in the OBR block, starting at 1
OBX-2	Value Type	R	“SN”, “NM”, or “CWE”
OBX-3	Observation Identifier	R	Observation’s ID
OBX-4	Observation Sub-ID	R	The containment value of the alert appended with “.2” Refer to Appendix B for containment values.
OBX-5	Observation Value	R	The observation’s value
OBX-6	Units	R	The observation’s units. See Table 14 for values.
OBX-7	Reference Range	O	L-H or <H or >L. See Note 1 below.
OBX-8	Abnormal Flags	O	”INV” if invalid “DEMO” if demo data
OBX-11	Observation Result Status	R	“F” or “X”
OBX-14	Observation Date/Time	R	YYYY[MM[DD[HH[MM[SS.mmm]]]]] [+/-ZZZZ]
OBX-18	Equipment Instance Identifier	RE	The source devices identifier

Note 1:

OBX-7 shall be populated with the thresholds of the alarm in the following formats.

For a high and Low threshold the format is “L-H” where “L” is the low threshold and “H” is the high threshold. For example for a low limit of 30 and a high limit of 120 the value would be:

30-120

For only a high limit the format is “<H”, where H is the high limit. For example with only a high limit of 120 the value would be:

<120

For only a low limit the format is “>L”, where L is the low limit. For example with only a low limit of 30 the value would be:

>30

Non-Threshold Alerts

Field	Name	Mindray Usage	
OBX-1	Set ID-OBX	R	An integer that is incremented for each OBX in the OBR block, starting at 1
OBX-2	Value Type	R	“CWE”
OBX-3	Observation Identifier	R	“68480^MDC_ATTR_ALERT_SOURCE^MDC”
OBX-4	Observation Sub-ID	R	The containment value of the alert appended with “.2” Refer to Appendix B for containment values.
OBX-5	Observation Value	R	“70041^MDC_DEV_SYS_ANESTH_MDS^MDC”
OBX-11	Observation Result Status	R	“F”

5.3.5.3 Alert OBX segment, Facet 3 Event Phase

This OBX specifies the phase of the alert event.

Field	Name	Mindray Usage	
OBX-1	Set ID-OBX	R	An integer that is incremented for each OBX in the OBR block, starting at 1
OBX-2	Value Type	R	“ST”
OBX-3	Observation Identifier	R	“68481^MDC_ATTR_EVENT_PHASE^MDC”
OBX-4	Observation Sub-ID	R	The containment value of the alert appended with “.3” Refer to Appendix B for containment values.
OBX-5	Observation Value	R	See 6 below
OBX-11	Observation Result Status	R	“F”

Table 6 Alert Phases

Value	Phase
tpoint	The alert is a time point with no duration. This will be the only event for this alert.
start	The alert started. Transitioned to active.
continue	The message is not a transition, it is just a resend of the current event state
end	The alert has ended. Transitioned from active to inactive or latched.
update	A change other than a state transition in a previously reported alarm, such as a further change in an out-of-limit metric.
escalate	The alert has escalated in priority.
de-escalate	The alert has de-escalated in priority.
reset	The alert was reset. Transitioned from latched to inactive.
inactivation	The inactivation state has changed (audio pause, alarm pause, etc...).
acknowledged	The alert has been acknowledged at the source device

5.3.5.4 Alert OBX segment, Facet 4 Alarm State

This OBX specifies the state of the alert.

Field	Name	Mindray Usage	
OBX-1	Set ID-OBX	R	An integer that is incremented for each OBX in the OBR block, starting at 1
OBX-2	Value Type	R	“ST”
OBX-3	Observation Identifier	R	“68482^MDC_ATTR_ALARM_STATE^MDC”
OBX-4	Observation Sub-ID	R	The containment value of the alert appended with “.4” Refer to Appendix B for containment values.
OBX-5	Observation Value	R	See Table 7 below
OBX-11	Observation Result Status	R	“F”

Table 7 Alert States

Value	State
inactive	The alarm is inactive. The alarm condition does not exist and the alarm system does not have an associated alarm.
active	The alarm is active. The alarm condition exists and the alarm system has an associated active alarm.
latched	The alarm is latched. The alarm condition is gone but the alarm system is keeping the associated alarm active.

5.3.5.5 Alert OBX segment, Facet 5 Inactivation State

This OBX specifies the inactivation state of the of the alerts signals. This segment is optional and will only be sent if the information is available.

Field	Name	Mindray Usage	
OBX-1	Set ID-OBX	R	An integer that is incremented for each OBX in the OBR block, starting at 1
OBX-2	Value Type	R	“ST”
OBX-3	Observation Identifier	R	“68483^MDC_ATTR_ALARM_INACTIVATION_STATE^MDC”
OBX-4	Observation Sub-ID	R	The containment value of the alert appended with “.5” Refer to Appendix B for containment values.
OBX-5	Observation Value	R	See Note 1 below
OBX-11	Observation Result Status	R	“F”

Note 1:

The OBX-5 field can be populated with up to 3 field repetitions. One from each of the tables below.

Table 8 Audio Inactivation States

Value	Alarm Audio State
<blank>	The alarm’s audio and visual indicators are enabled.
audio-paused	The alarm’s audio indicator is temporarily off
audio-off	The alarm’s audio indicator permanently off

Table 9 Visual Inactivation States

Value	Alarm Visual State
<blank>	The alarm’s audio and visual indicators are enabled.
alarm-paused	The alarm’s visual indicator is temporarily off
alarm-off	The alarm’s visual indicator is permanently off

Table 10 Acknowledgement State

Value	Acknowledgement State
<blank>	The alarm has not been acknowledged at the source.
alert-acknowledged	The alarm has been acknowledged at the source.

5.3.5.6 Alert OBX segment, Facet 6 Alarm Priority

This OBX specifies the alarm priority.

Field	Name	Mindray Usage	Network Port
OBX-1	Set ID-OBX	R	An integer that is incremented for each OBX in the OBR block, starting at 1
OBX-2	Value Type	R	“ST”
OBX-3	Observation Identifier	R	“68484^MDC_ATTR_ALARM_PRIORITY^MDC”
OBX-4	Observation Sub-ID	R	The containment value of the alert appended with “.6” Refer to Appendix B for containment values.
OBX-5	Observation Value	R	See Table 11 below
OBX-11	Observation Result Status	R	“F”

Table 11 Alarm Priority

Value	Alarm Priority
PN	No alarm
PL	Low priority
PM	Medium priority
PH	High priority

Table 12 Facet 6 and 7 Values Based on Alert Type

Alert Type	Facet 6 OBX-5	Facet 7 OBX-5
High Priority Physiological	PH	SP
Medium Priority Physiological	PM	SP
Low Priority Physiological	PL	SP
High Priority Technical	PH	ST
Medium Priority Technical	PM	ST
High Priority Technical	PH	ST
Advisory	PN	SA

5.3.5.7 Alert OBX segment, Facet 7 Alert Type

This OBX specifies the alert type.

Field	Name	Mindray Usage	
OBX-1	Set ID-OBX	R	An integer that is incremented for each OBX in the OBR block, starting at 1
OBX-2	Value Type	R	“ST”
OBX-3	Observation Identifier	R	“68485^MDC_ATTR_ALERT_TYPE^MDC”
OBX-4	Observation Sub-ID	R	The containment value of the alert appended with “.7” Refer to Appendix B for containment values.
OBX-5	Observation Value	R	See Table 13 below
OBX-11	Observation Result Status	R	“F”

Table 13 Alarm Type

Value	Alarm Type
SP	Physiological
ST	Technical
SA	Advisory

FOR YOUR NOTES

6 Time Synchronization

6.1 CT (Consistent Time) Profile:

The A-Series device supports the IHE Consistent Time (CT) Profile (ITI-01) only on the Ethernet port.

This profile supports the synchronization of time between a Time Server and a Time Client and is based on the IETF standard SNTP protocol. The Time Client periodically transmits synchronization request (using UDP) to the Time Server. The request interval as well as IP Address of the Time Server is configured on the Anesthesia System.

The A-Series anesthesia machines play a Time Client role in the IHE CT profile.

If a Time Server is not available then the Anesthesia System will try to connect again after the configured interval. If the connection attempt fails 5 times in a row, the Anesthesia System will display a “Could not locate time server” prompt message. This prompt message will be displayed until the connection attempt succeeds.

IHE ITI Time Client application system architecture:

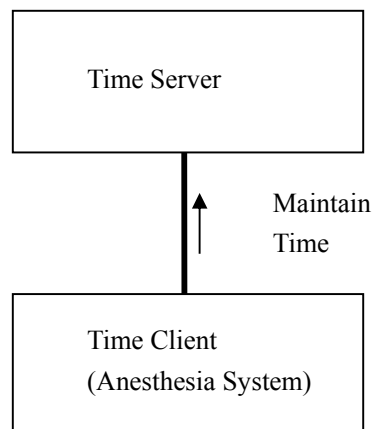

6.2 Introduction to the SNTP Protocol

As mentioned previously, when the Network Port is used the A-Series can use the IHE Consistent Time (CT) profile to obtain system time. This profile uses SNTP which is simple network protocol based on RFC 2030. It uses the same protocol as NTP except the unique difference that SNTP does not include measurement data which the NTP high-accuracy data estimation algorithm uses. The SNTP protocol is applicable to hosts which do not require a full implementation of the NTP complex algorithm. SNTP is a subset of NTP, it uses UDP protocol with “well-known” port of 123.

The Mindray anesthesia system acts as a Client in this Client/Server system, however it does initiate the requests to the server. The message format is as follows:

0		7		15		23		31
LI	VN	Mode	Stratum	Poll Interval	Precision			
Root Delay (32)								
Root Dispersion (32)								
Reference Identifier (32)								
Reference Timestamp (64)								
Originate Timestamp (64)								
Receive Timestamp (64)								
Transmit Timestamp (64)								

For a definition of each field in an SNTP message, refer to “*RFC 2030 Simple Network Protocol*”.

6.2.1 UDP Layer

The figure below shows the Network communication layers involved in the communication between Mindray anesthesia systems and communication partners.

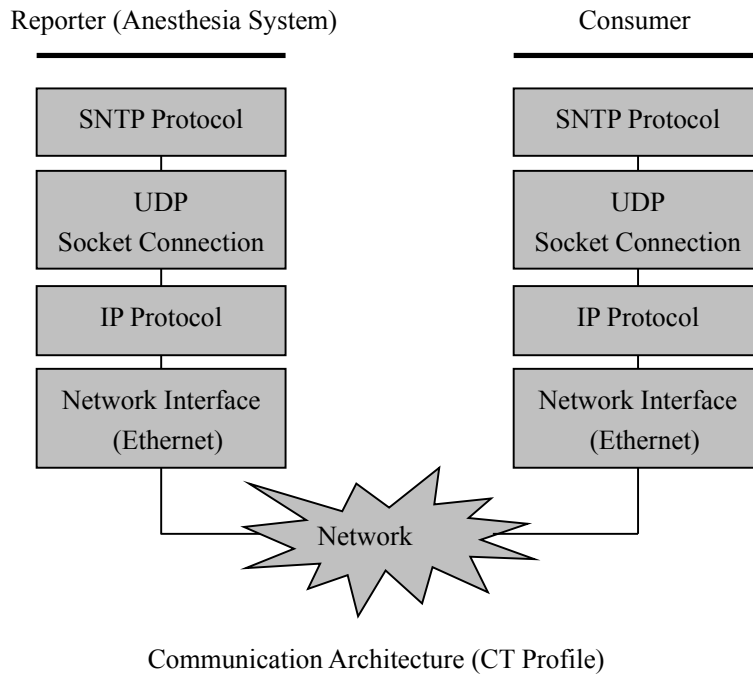

Corresponding to “UDP” layer in the Communication Architecture (CT Profile).

- Connectionless Socket Service
- Use TCP/IP stack protocol
- Ethernet driver interface
- All networking information (IP address, Subnet, Gateway) is entered by the user manually

6.2.2 Packet Assembly

SNTP data format that SNTP contains 48 bytes which are divided into five parts: SNTP header, time stamp T1, time stamp T2, time stamp T3, and time stamp T4.

Header information: configuration information of the current sender

- T1: time point when Client sends a request
- T2: time point when Server receives the request
- T3: time point when Server sends a response
- T4: time point when Client receives the response

As Client, Mindray anesthesia system only sends request packets. The request packet mainly contains header information and T1 time stamp. The following gives an example of a completed request packet.

0		7		15		23		31
00	011	011	00000000	00000000	00000000	00000000	00000000	
0x00000000								
0x00000000								
0x00000000								
0x00000000 0x00000000								
0x00000000 0x00000000								
0x00000000 0x00000000								
0xD0C2D77D 0x00000000								

Note: 0xD0C2D77D represent the UTC time of 2010-12-27 9 :14 :37.

After receiving this message, the Time Server fills T2 time stamp and T3 time stamp. Then it sends the assembled new data packet back to the Client for time synchronization to the master clock.

6.2.3 SNTP C/S Illustration

CT client work illustration:

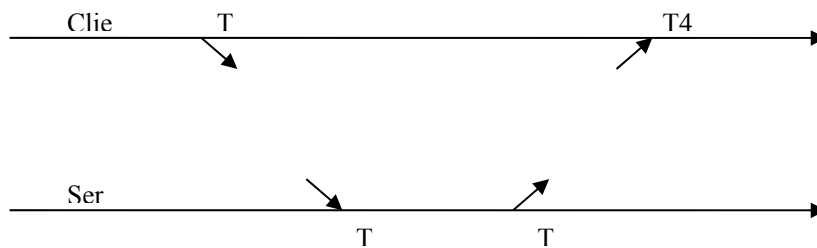

Note: for time calibration algorithm, refer to “RFC 2030 Simple Network Protocol”

A CRC Calculation

A.1 Overview

As depicted in section 2.1.1.1 the Serial Protocol uses a CRC based on the IETF RFC 1171 for HDLC framing. The CRC is calculated to 16 bits on the HL7 message and does not include the MLLP framing characters. It is inserted towards the end of the Serial export message using 4 ASCII characters in Hex. For example if the CRC is 0x1F2Eh, the CRC is inserted as 1F2E.

A.2 CRC Calculation Guidance

Below is a C++ class for reference that performs the CRC based on the IETF RFC 1171 for HDLC framing. It can easily be converted into a C function if needed.

```
class CRC
{
private:
    static unsigned short s_CRCTable[256];
    unsigned short m_Value;

public:
    CRC():m_Value(0){}
    unsigned short GetValue() const { return m_Value;}
    void Reset() {m_Value = 0;}
    void Calculate( const unsigned char* data, size_t length);
};

const unsigned short CRC::s_CRCTable[256] =
{
0x0000, 0x1189, 0x2312, 0x329b, 0x4624, 0x57ad, 0x6536, 0x74bf,
0x8c48, 0x9dc1, 0xaf5a, 0xbed3, 0xca6c, 0xdbe5, 0xe97e, 0xf8f7,
0x1081, 0x0108, 0x3393, 0x221a, 0x56a5, 0x472c, 0x75b7, 0x643e,
0x9cc9, 0x8d40, 0xbfdb, 0xae52, 0xdaed, 0xcb64, 0xf9ff, 0xe876,
0x2102, 0x308b, 0x0210, 0x1399, 0x6726, 0x76af, 0x4434, 0x55bd,
0xad4a, 0xbcc3, 0x8e58, 0x9fd1, 0xeb6e, 0xfae7, 0xc87c, 0xd9f5,
0x3183, 0x200a, 0x1291, 0x0318, 0x77a7, 0x662e, 0x54b5, 0x453c,
0xbdcb, 0xac42, 0x9ed9, 0x8f50, 0xfbef, 0xea66, 0xd8fd, 0xc974,
0x4204, 0x538d, 0x6116, 0x709f, 0x0420, 0x15a9, 0x2732, 0x36bb,
0xce4c, 0xdfc5, 0xed5e, 0xfcd7, 0x8868, 0x99e1, 0xab7a, 0xbaf3,
0x5285, 0x430c, 0x7197, 0x601e, 0x14a1, 0x0528, 0x37b3, 0x263a,
0xdecd, 0xcf44, 0xfddf, 0xec56, 0x98e9, 0x8960, 0xbbfb, 0xaa72,
```

```
0x6306, 0x728f, 0x4014, 0x519d, 0x2522, 0x34ab, 0x0630, 0x17b9,
0xef4e, 0xfec7, 0xcc5c, 0xdd5, 0xa96a, 0xb8e3, 0x8a78, 0x9bf1,
0x7387, 0x620e, 0x5095, 0x411c, 0x35a3, 0x242a, 0x16b1, 0x0738,
0xffcf, 0xee46, 0xdcdd, 0xcd54, 0xb9eb, 0xa862, 0x9af9, 0x8b70,
0x8408, 0x9581, 0xa71a, 0xb693, 0xc22c, 0xd3a5, 0xe13e, 0xf0b7,
0x0840, 0x19c9, 0x2b52, 0x3adb, 0x4e64, 0x5fed, 0x6d76, 0x7cff,
0x9489, 0x8500, 0xb79b, 0xa612, 0xd2ad, 0xc324, 0xf1bf, 0xe036,
0x18c1, 0x0948, 0x3bd3, 0x2a5a, 0x5ee5, 0x4f6c, 0x7df7, 0x6c7e,
0xa50a, 0xb483, 0x8618, 0x9791, 0xe32e, 0xf2a7, 0xc03c, 0xd1b5,
0x2942, 0x38cb, 0x0a50, 0x1bd9, 0x6f66, 0x7eef, 0x4c74, 0x5dfd,
0xb58b, 0xa402, 0x9699, 0x8710, 0xf3af, 0xe226, 0xd0bd, 0xc134,
0x39c3, 0x284a, 0x1ad1, 0x0b58, 0x7fe7, 0x6e6e, 0x5cf5, 0x4d7c,
0xc60c, 0xd785, 0xe51e, 0xf497, 0x8028, 0x91a1, 0xa33a, 0xb2b3,
0x4a44, 0x5bcd, 0x6956, 0x78df, 0x0c60, 0x1de9, 0x2f72, 0x3efb,
0xd68d, 0xc704, 0xf59f, 0xe416, 0x90a9, 0x8120, 0xb3bb, 0xa232,
0x5ac5, 0x4b4c, 0x79d7, 0x685e, 0x1ce1, 0x0d68, 0x3ff3, 0x2e7a,
0xe70e, 0xf687, 0xc41c, 0xd595, 0xa12a, 0xb0a3, 0x8238, 0x93b1,
0x6b46, 0x7acf, 0x4854, 0x59dd, 0x2d62, 0x3ceb, 0x0e70, 0x1ff9,
0xf78f, 0xe606, 0xd49d, 0xc514, 0xb1ab, 0xa022, 0x92b9, 0x8330,
0x7bc7, 0x6a4e, 0x58d5, 0x495c, 0x3de3, 0x2c6a, 0x1ef1, 0x0f78
};
```

```
void UInt16FCS::Calculate( const unsigned char* data, size_t length)
{
    const unsigned char* endPtr = data + length;
    while(data < endPtr)
        m_Value = (m_Value >> 8) ^ s_CRCTable[(m_Value ^ *data++) & 0xff];
}
```

B A-Series HL7 Export Nomenclature

B.1 General ID Allocation Scheme for “99MNDRY” Terms

Wherever possible Standards based 11073-10101 terms have been used. These are denoted by “MDC” as OBX 3.3. In situations where terms were not yet available we have developed a private code space which is denoted by “99MNDRY”.

Range	Purpose
00000 – 09999	Measurements
10000 – 19999	Units of Measure (UoM)
20000 – 29999	Settings
30000 – 39999	Status
40000 – 49999	Body Sites
50000 – 59999	Modes

B.2 A-Series - Anesthesia Machine Containment Tree

This table defines the value used in OBX-4 Observation Sub-ID to help define the source of the measurement, setting, or alert. Observations with identical OBX-3 Observation ID can be distinguished from each other by looking at the OBX-4 value of the observation. The Sub-ID uses the following format: M.V.C.I, where M = System (MDS), V = Virtual Device (VMD), C = Channel, I = Metric. This system is based on the IEEE 11073 standard.

M is set to 1 on the A-Series-Anesthesia Machine.

V is set to a number value defined in the containment tree representing the sub-system (Ventilator, Airway Gas Analyzer, Agent, etc.) to which the observation belongs.

C is the channel can be used to distinguish between identical observations types taken by different sensors. C can also be used to create sub-categories for V. For example the sub-system Ventilator may have an Airway Pressure channel, an Airway Flow Channel, and an Airway Volume channel.

I is the value of OBX-3.1 in the OBX segment of the observation.

Anesthesia System Containment Tree

Hierarchy			Containment (M.V.C.I)
MDS	Anesthesia System	1	1
	VMD	Anesthesia System	1.1

	Channel	Status	1	1.1.1
VMD	Body Measurement		2	1.2
	Channel	Measurement	1	1.2.1
VMD	Ventilator		3	1.3
	Channel	Status	1	1.3.1
	Channel	Ventilation	2	1.3.2
	Channel	Fresh Gas	3	1.3.3
VMD	Airway Gas Analyzer		4	1.4
	Channel	Airway Gas	1	1.4.1
VMD	CO2		8	1.8
	Channel	CO2	1	1.8.1
VMD	Agent		9	1.9
	Channel	Primary Agent	1	1.9.1
	Channel	Secondary	2	1.9.2
VMD	Airway Multi-Parameter		11	1.11
	Channel	Ariway Pressure	1	1.11.1
	Channel	Ariway Flow	2	1.11.2
	Channel	Ariway Volume	3	1.11.3
VMD	Anesthesia Machine		14	1.14

B.3 Units of Measure

Table 14 Units of Measure

Unit of Measure	OBX-6.1	OBX-6.2	OBX-6.3	Comment
l/min	265216	MDC_DIM_L_PER_MIN	MDC	/
ml	263762	MDC_DIM_MILLI_L	MDC	/
cmH2O	266048	MDC_DIM_CM_H2O	MDC	/
s	264320	MDC_DIM_SEC	MDC	/
kg	263875	MDC_DIM_KILO_G	MDC	Gram*10 ³
cmH2O/l/s	268064	MDC_DIM_CM_H2O_PER_L_PER_SEC	MDC	/
ml/cmH2O	268050	MDC_DIM_MILLI_L_PER_CM_H2O	MDC	/
mmHg	266016	MDC_DIM_MMHG	MDC	/
Hz	264640	MDC_DIM_HZ	MDC	/
/min	264672	MDC_DIM_PER_MIN	MDC	/
rpm	264928	MDC_DIM_RESP_PER_MIN	MDC	/
bpm	264864	MDC_DIM_BEAT_PER_MIN	MDC	/

dB	268576	MDC_DIM_DECIBEL	MDC	/
Unitless	262656	MDC_DIM_DIMLESS	MDC	No unit of measure
%	262688	MDC_DIM_PERCENT	MDC	/
uV	266419	MDC_DIM_MICRO_VOLT	MDC	Volt*10 ⁻⁶
ml/h	265266	MDC_DIM_MILLI_L_PER_HR	MDC	/
cm	263441	MDC_DIM_CENTI_M	MDC	/

B.4 Ventilator / Anesthesia Machine Settings IDs

Only settings that are valid for a specific device mode will be sent.

Setting	OBX-3.1	OBX-3.2	OBX-3.3	UoM	OBX-4	Module	Comment
I:E	16929048	MDC_RATIO_IE_SETTING	MDC	Unitless	1.3.2.16929048	Vent.	/
F-trigger	16930020	MDC_VENT_FLOW_TRIG_SENS_SETTING	MDC	l/min	1.3.2.16930020	Vent.	/
Vt	16929196	MDC_VENT_VOL_TIDAL_SETTING	MDC	ml	1.3.2.16929196	Vent.	/
Rate	16928802	MDC_VENT_RESP_RATE_SETTING	MDC	rpm	1.3.2.16928802	Vent.	/
MinRate	16929698	MDC_VENT_RESP_BACKUP_RATE_SETTING	MDC	rpm	1.3.2.16929698	Vent.	/
PEEP	16929192	MDC_VENT_PRESS_AWAY_END_EXP_POS_SETTING	MDC	cmH ₂ O	1.3.2.16929192	Vent.	/
Plimit	16929964	MDC_VENT_PRESS_AWAY_LIMIT_SETTING	MDC	cmH ₂ O	1.3.2.16929964	Vent.	/
Pinsp	16929188	MDC_VENT_PRESS_AWAY_SETTING	MDC	cmH ₂ O	1.3.2.16929188	Vent.	/
ΔPsupp	16929952	MDC_VENT_PRESS_AWAY_DELTA_SUPP_SETTING	MDC	cmH ₂ O	1.3.2.16929952	Vent.	/
Tinsp	16929632	MDC_VENT_TIME_PD_INSP_SETTING	MDC	s	1.3.2.16929632	Vent.	/
Tslope	16929984	MDC_VENT_PRESS_AWAY_RISETIME_CTLD_SETTING	MDC	s	1.3.2.16929984	Vent.	/

Setting	OBX-3.1	OBX-3.2	OBX-3.3	UoM	OBX-4	Module	Comment
Tpause	1692984	MDC_VENT_TIME_PD_INSP_PAUSE_PERCENT_SETTING	MDC	%	1.3.2.16929844	Vent.	/
ApneaTi	1692983	MDC_VENT_TIME_PD_INSP_BACKUP_SETTING	MDC	s	1.3.2.16929832	Vent.	/
O2 Flow	1693037	MDC_FLOW_O2_FG_SETTING	MDC	l/min	1.3.3.16930372	Fresh Gas	/
N2O Flow	1693030	MDC_FLOW_N2O_FG_SETTING	MDC	l/min	1.3.3.16930308	Fresh Gas	/
AIR Flow	1693009	MDC_FLOW_AIR_FG_SETTING	MDC	l/min	1.3.3.16930092	Fresh Gas	/
Apnea I:E	20043	MNDRY_VENT_APNEA_RATIO_IE_SETTING	99MNDRY	Unitless	1.3.2.20043	Vent.	/
Exp%	20026	MNDRY_VENT_EXP_TRIGGER_SETTING	99MNDRY	%	1.3.2.20026	Vent.	/
P-Trig	1692964	MDC_VENT_PRESS_TRIGGER_SENS_SETTING	MDC	cmH20	1.3.2.16929644	Vent.	/
Trig Window	20044	MNDRY_VENT_TRIGGER_WINDOW_SETTING	99MNDRY	%	1.3.2.20044	Vent.	/
△ Papnea	1692994	MDC_VENT_PRESS_AWAY_DELTA_BACKUP_SETTING	MDC	cmH20	1.3.2.16929944	Vent	/
Phigh	1692995	MDC_VENT_PRESS_AWAY_INSP_PHIGH_SETTING	MDC	cmH20	1.3.2.16929956	Vent	/
Plow	1692996	MDC_VENT_PRESS_AWAY_EXP_PLOW_SETTING	MDC	cmH20	1.3.2.16929960	Vent	/
Thigh	1692986	MDC_VENT_TIME_PD_INSP_THIGH_SETTING	MDC	s	1.3.2.16929860	Vent	/

Setting	OBX-3.1	OBX-3.2	OBX-3.3	UoM	OBX-4	Module	Comment
Tlow	16929864	MDC_VENT_TIME_PD_EXP_TLOW_SETTING	MDC	s	1.3.2.16929864	Vent	/
Breaths	20046	MNDRY_RM_AUTO_MODE_BREATHS_SETTING	99MNDRY	/	1.3.2.20046	Vent	Recruitment
Pressure Hold	20089	MNDRY_RM_MANUAL_HOLD_PRESS_SETTING	99MNDRY	cmH20	1.3.2.20089	Vent	Recruitment
Hold Time	20090	MNDRY_RM_MANUAL_PD_HOLD_SETTING	99MNDRY	s	1.3.2.20090	Vent	Recruitment

B.5 Ventilation Modes

Parameter	OBX-3.1	OBX-3.2	OBX-3.3	UoM	OBX-4	Module	Values
Mode	184352	MDC_VENT_MODE	MDC	Unitless	1.3.1.184352	Vent	See Table 15

Table 15 Ventilation Mode Values

Mode	OBX-5.1	OBX-5.2	OBX-5.3	Description
Manual	50000	MNDRY_VENT_MODE_MANUAL	99MNDRY	Manual Ventilation
ACGO	50001	MNDRY_VENT_MODE_ACGO	99MNDRY	Auxiliary Common Gas Outlet
Manual + Alarms Off	50002	MNDRY_VENT_MODE_MANUAL_PLUS_ALM_OFF	99MNDRY	Manual Ventilation with Alarms Off
Manual + Bypass	50003	MNDRY_VENT_MODE_MANUAL_PLUS_BYPASS	99MNDRY	Cardiac Bypass
Manual + Monitor	50004	MNDRY_VENT_MODE_MANUAL_PLUS_MONITOR	99MNDRY	Monitor with AG module
VCV	50005	MNDRY_VENT_MODE_VCV	99MNDRY	Volume Control Ventilation
PS	50006	MNDRY_VENT_MODE_PS	99MNDRY	Pressure Support
SIMV-VC + PS	50008	MNDRY_VENT_MODE_SIMVVC_PLUS_PS	99MNDRY	Synchronized Intermittent Mandatory Ventilation-Volume Control with Pressure Support.

Mode	OBX-5.1	OBX-5.2	OBX-5.3	Description
SIMV-PC + PS	50010	MNDRY_VENT_MODE_SIMVPC_PLUS_PS	99MNDRY	Synchronized Intermittent Mandatory Ventilation-Pressure Control with Pressure Support.
PCV	50011	MNDRY_VENT_MODE_PCV	99MNDRY	Pressure Control Ventilation
PCV + VG	50012	MNDRY_VENT_MODE_PCV_PLUS_VG	99MNDRY	Pressure Control Ventilation with Volume Guarantee
AVNF	50013	MNDRY_MODE_AVNF	99MNDRY	Auto-Ventilation Non-Functional
CPAP + PS	50021	MNDRY_VENT_MODE_CPAP_PLUS_PS	99MNDRY	Continuous Positive Airway Pressure w/Pressure Support
APRV	50017	MNDRY_VENT_MODE_APRV	99MNDRY	Airway Pressure Release Ventilation
RM	50023	MNDRY_VENT_MODE_RM	99MNDRY	Recruitment Maneuver
SIMV-VG+ PS	50035	MNDRY_VENT_MODE_SIMVVG_PLUS_PS	99MNDRY	SIMV Volume Guarantee w/Pressure Support
VCV + Bypass	50063	MNDRY_VENT_MODE_VCV_PLUS_BYPASS	99MNDRY	VCV Bypass

B.6 System Status

Parameter	OBX-3.1	OBX-3.2	OBX-3.3	UoM	OBX-4	Module	Values
Device Status	202886	MDC_EVT_STAT_DEV	MDC	Unitless	1.1.1.202886	System	See Table 16
Device Mode	30002	MNDRY_EVT_STAT_MODE_DEV	99MNDR Y	Unitless	1.1.1.30002	System	See Table 17
Patient Type	30005	MNDRY_EVT_STAT_PATIENT_TYPE	99MNDR Y	Unitless	1.1.1.30005	System	See Table 18
Warmer On	30007	MNDRY_EVT_STAT_WARMER_ON_BOOL	99MNDR Y	Unitless	1.3.1.30007	Warmer	See Table 19

Table 16 Device Status Values

Device Status	OBX-5 .1	OBX-5.2	OBX-5.3	Comment
Off	202834	MDC_EVT_STAT_OFF	MDC	Device is off. Sent (if possible) during power down sequence
Running	202902	MDC_EVT_STAT_RUNNING	MDC	Device is running.
Standby/ Discharge	202836	MDC_EVT_STAT_STANDBY	MDC	Device is in Standby

Table 17 Device Mode Values

Device Mode	OBX-5 .1	OBX-5.2	OBX-5.3	Comment
Normal	30003	MNDRY_EVT_STAT_MODE_NORMAL	99MNDR Y	Device is normal operating mode.
Service	202840	MDC_EVT_STAT_MODE_TEST	MDC	Device is in service mode.
Demo	30004	MNDRY_EVT_STAT_MODE_DEMO	99MNDR Y	Device is in demo mode.

Table 18 Patient Type Values

Patient Type	OBX-5 .1	OBX-5.2	OBX-5.3	Comment
Adult	202890	MDC_EVT_STAT_DEV_MODE_ADULT	MDC	Patient is adult size.
Pediatric	202888	MDC_EVT_STAT_DEV_MODE_PEDIATRIC	MDC	Patient is adult pediatric.
Infant	30006	MNDRY_EVT_STAT_DEV_MODE_INFANT	99MNDR Y	Patient is adult infant.

Table 19 Boolean Type Values

Value	OBX-5 .1	OBX-5.2	OBX-5.3	Comment
True	30000	MDC_TRUE	99MNDR Y	Condition is true.
False	30001	MDC_FALSE	99MNDR Y	Condition is false.

B.7 Patient Measurements

Parameter	OBX-3.1	OBX-3.2	OBX-3.3	UoM	OBX-4	Module	Comment
Weight	188736	MDC_MASS_BODY_ACTUAL	MDC	kg	1.2.1.188736	System	

B.8 Ventilator / Anesthesia Machine Measurement IDs

Parameter	OBX-3.1	OBX-3.2	OBX-3.3	UoM	OBX-4	Module	Comment
I:E	151832	MDC_RATIO_IE	MDC	Unitless	1.3.2.151832	Vent.	HL7 SN Type
Peak	151793	MDC_PRESS_AWAY_MAX	MDC	cmH2O	1.3.2.151793	Vent.	/
Mean	151819	MDC_PRESS_AWAY_INSP_MEAN	MDC	cmH2O	1.3.2.151819	Vent.	/
Plat	151784	MDC_PRESS_RESP_PLAT	MDC	cmH2O	1.3.2.151784	Vent.	/
PEEP	151976	MDC_VENT_PRESS_AWAY_END_EXP_POS	MDC	cmH2O	1.3.2.151976	Vent.	/
MV	151880	MDC_VOL_MINUTE_AWAY	MDC	l/min	1.3.2.151880	Vent.	/
VtExp	152664	MDC_VOL_AWAY_TIDAL_EXP	MDC	ml	1.3.2.152664	Vent.	/
VtInsp	152660	MDC_VOL_AWAY_TIDAL_INSP	MDC	ml	1.3.2.152660	Vent.	/
ΔV_t	550	MNDRY_VOL_AWAY_TIDAL_DELTA	99MNDRY	ml	1.3.2.550	Vent.	/
Rate	151570	MDC_AWAY_RESP_RATE	MDC	rpm	1.3.2.151570	Vent.	/
R	151840	MDC_RES_AWAY	MDC	cmH2O/l/s	1.3.2.151840	Vent.	/
C	151688	MDC_COMPL_LUNG	MDC	ml/cmH20	1.3.2.151688	Vent.	/
O2 Flow	153156	MDC_FLOW_O2_FG	MDC	l/min	1.3.3.153156	Fresh Gas	/
N2O Flow	153092	MDC_FLOW_N2O_FG	MDC	l/min	1.3.3.153092	Fresh Gas	/
AIR Flow	152876	MDC_FLOW_AIR_FG	MDC	l/min	1.3.3.152876	Fresh Gas	/

Parameter	OBX-3.1	OBX-3.2	OBX-3.3	UoM	OBX-4	Module	Comment
step	499	MNDRY_RM_AUTO_MODE_STEP	99MNDR Y	/	1.3.2.499	Vent.	/

B.9 Airway Gas Analyzer Measurement IDs

Parameter	OBX-3.1	OBX-3.2	OBX-3.3	UoM	OBX-4	Module	Comment
EtO2	152440	MDC_CONC_AWAY_O2_ET	MDC	%	1.4.1.152440	AG	Exp O2
FiO2	152196	MDC_CONC_AWAY_O2_INSP	MDC	%	1.4.1.152196	AG	FiO2 in A3/A5; Insp O2 in A7
EtCO2	151708	MDC_CONC_AWAY_CO2_ET	MDC	mmHg	1.4.1.151708	AG	EtCO2
FiCO2	151716	MDC_CONC_AWAY_CO2_INSP	MDC	mmHg	1.4.1.151716	AG	FiCO2
Rate	151594	MDC_CO2_RESP_RATE	MDC	rpm	1.4.1.151594	AG	Resp Rate from CO2
EtN2O	152108	MDC_CONC_AWAY_N2O_ET	MDC	%	1.4.1.152108	AG	Exp N2O
FiN2O	152192	MDC_CONC_AWAY_N2O_INSP	MDC	%	1.4.1.152192	AG	Insp N2O
EtAA	152460	MDC_CONC_AWAY_AGENT_ET	MDC	%	1.4.1.152460	AG	Exp Agent .
FiAA	152464	MDC_CONC_AWAY_AGENT_INSP	MDC	%	1.4.1.152464	AG	Insp Agent
EtHal	152092	MDC_CONC_AWAY_HALOTH_ET	MDC	%	1.4.1.152092	AG	Exp Hal .
FiHal	152176	MDC_CONC_AWAY_HALOTH_INSP	MDC	%	1.4.1.152176	AG	Insp Hal
UsageHal	152932	MDC_VOL_DELIV_HALOTH_LIQUID_CASE	MDC	ml	1.4.1.152932	AG	Hal. usage for case
EtEnf	152088	MDC_CONC_AWAY_ENF_NFL_ET	MDC	%	1.4.1.152088	AG	Exp Enf .
FiEnf	152172	MDC_CONC_AWAY_ENF_NFL_INSP	MDC	%	1.4.1.152172	AG	Insp Enf .
UsageEnf	152916	MDC_VOL_DELIV_ENF_FL_LIQUID_CASE	MDC	ml	1.4.1.152916	AG	Enf. usage for case
EtIso	152100	MDC_CONC_AWAY_ISO	MDC	%	1.4.1.152100	AG	Exp Iso .

Parameter	OBX-3.1	OBX-3.2	OBX-3.3	UoM	OBX-4	Module	Comment
		SOFL_ET					
FiIso	152184	MDC_CONC_AWAY_I SOFL_INSP	MDC	%	1.4.1.152184	AG	Insp Iso .
UsageIso	152948	MDC_VOL_DELIV_ISO FL_LIQUID_CASE	MDC	ml	1.4.1.152948	AG	Iso. usage for case
EtSev	152096	MDC_CONC_AWAY_S EVOFL_ET	MDC	%	1.4.1.152096	AG	Exp Sev .
FiSev	152180	MDC_CONC_AWAY_S EVOFL_INSP	MDC	%	1.4.1.152180	AG	Insp Sev .
UsageSev	152980	MDC_VOL_DELIV_SE VOFL_LIQUID_CASE	MDC	ml	1.4.1.152980	AG	Sev. usage for case
EtDes	152084	MDC_CONC_AWAY_D ESFL_ET	MDC	%	1.4.1.152084	AG	Exp Des .
FiDes	152168	MDC_CONC_AWAY_D ESFL_INSP	MDC	%	1.4.1.152168	AG	Insp Des .
UsageDes	152900	MDC_VOL_DELIV_DE SFL_LIQUID_CASE	MDC	ml	1.4.1.152900	AG	Des. usage for case
MAC	152872	MDC_CONC_MAC	MDC	DimLess	1.4.1.152872	AG	MAC .
RateHAL	293	MNDRY_FLOW_DELI V_HALOTH_LIQUID	99MND RY	ml/h	1.4.1.293	AG	Hal. consumpti on per hour
RateENF	294	MNDRY_FLOW_DELI V_ENFL_LIQUID	99MND RY	ml/h	1.4.1.294	AG	Enf. consumpti on per hour
RateISO	295	MNDRY_FLOW_DELI V_ISOFL_LIQUID	99MND RY	ml/h	1.4.1.295	AG	Iso. consumpti on per hour
RateSEV	296	MNDRY_FLOW_DELI V_SEVOFL_LIQUID	99MND RY	ml/h	1.4.1.296	AG	Sev. consumpti on per hour
RateDES	297	MNDRY_FLOW_DELI V_DESFL_LIQUID	99MND RY	ml/h	1.4.1.297	AG	Des. consumpti on per hour

B.10 Waveform IDs

Table 20 Waveform IDs

Parameter	OBX-3.1	OBX-3.2	OBX-3.3	OBX-4	UoM	Module	Comment
CO2, Airway	151700	MDC_CONC_AWAY_CO2	MDC	1.8.1.151700	mmHg	AG	
O2, Airway	151908	MDC_CONC_AWAY_O2	MDC	1.9.1.151908	%	AG	
N2O, Airway	152048	MDC_CONC_AWAY_N2O	MDC	1.9.1.152048	%	AG	
Agent, Airway	152456	MDC_CONC_AWAY_AGENT	MDC	1.9.1.152456	%	AG	
Desflurane, Airway	152024	MDC_CONC_AWAY_DESFL	MDC	1.9.1.152024	%	AG	
Enflurane, Airway	152028	MDC_CONC_AWAY_ENFL	MDC	1.9.1.152028	%	AG	
Halothane, Airway	152032	MDC_CONC_AWAY_HALOTH	MDC	1.9.1.152032	%	AG	
Sevoflurane, Airway	152036	MDC_CONC_AWAY_SEVOFL	MDC	1.9.1.152036	%	AG	
Isoflurane, Airway	152040	MDC_CONC_AWAY_ISOFL	MDC	1.9.1.152040	%	AG	
Pressure, Airway	151792	MDC_PRESS_AWAY	MDC	1.11.1.151792	cmH2O	Vent	
Flow, Airway	151764	MDC_FLOW_AWAY	MDC	1.11.2.151764	L/min	Vent	
Volume, Airway	152708	MDC_VOL_AWAY	MDC	1.11.3.152708	mL	Vent	

B.11 Alert IDs

Table 21 Threshold Alarm IDs

Alert	OBX-3.1	OBX-3.2	OBX-3.3	OBX-4	Type (P or T)	Threshold (H or L)	Description
MV Too High	151880	MDC_VOL_MINUTE_AWAY	MDC	1.3.2.151880	P	H	Minute Volume is higher than or equal to the high alarm limit setting.

Alert	OBX-3.1	OBX-3.2	OBX-3.3	OBX-4	Type (P or T)	Threshold (H or L)	Description
MV Too Low	151880	MDC_VOL_MINUTE_AWAY	MDC	1.3.2.151880	P	L	Minute Volume is lower than or equal to the low alarm limit setting.
Paw Too High	151972	MDC_PRESS_AWAY	MDC	1.3.2.151972	P	H	Ventilation Airway Pressure is higher than or equal to the high alarm limit setting.
Paw Too Low	151972	MDC_PRESS_AWAY	MDC	1.3.2.151972	P	L	Ventilation Airway Pressure is lower than or equal to the low alarm limit setting for 20 seconds.
EtCO ₂ Too High	151708	MDC_CONC_AWAY_CO2_ET	MDC	1.4.1.151708	P	H	EtCO ₂ is higher than or equal to the high alarm limit setting.
EtCO ₂ Too Low	151708	MDC_CONC_AWAY_CO2_ET	MDC	1.4.1.151708	P	L	EtCO ₂ is lower than or equal to the low alarm limit setting.
FiCO ₂ Too High	151716	MDC_CONC_AWAY_CO2_INSP	MDC	1.4.1.151716	P	H	FiCO ₂ is higher than or equal to the high alarm limit setting.
FiCO ₂ Too Low	151716	MDC_CONC_AWAY_CO2_INSP	MDC	1.4.1.151716	P	L	FiCO ₂ is lower than or equal to the low alarm limit setting.
EtN ₂ O Too High	152108	MDC_CONC_AWAY_N2O_ET	MDC	1.4.1.152108	P	H	EtN ₂ O is higher than or equal to the high alarm limit setting.
EtN ₂ O Too Low	152108	MDC_CONC_AWAY_N2O_ET	MDC	1.4.1.152108	P	L	EtN ₂ O is lower than or equal to the low alarm limit setting.
FiN ₂ O Too High	152192	MDC_CONC_AWAY_N2O_INSP	MDC	1.4.1.152192	P	H	FiN ₂ O is higher than or equal to the high alarm limit setting.

Alert	OBX-3.1	OBX-3.2	OBX-3.3	OBX-4	Type (P or T)	Threshold (H or L)	Description
FiN ₂ O Too Low	152192	MDC_CONC_AWAY_N2O_INSP	MDC	1.4.1.152192	P	L	FiN ₂ O is lower than or equal to the low alarm limit setting.
EtO ₂ Too High	152440	MDC_CONC_AWAY_O2_ET	MDC	1.4.1.152440	P	H	EtO ₂ is higher than or equal to the high alarm limit setting.
EtO ₂ Too Low	152440	MDC_CONC_AWAY_O2_ET	MDC	1.4.1.152440	P	L	EtO ₂ is lower than or equal to the low alarm limit setting.
FiO ₂ Too High	152196	MDC_CONC_AWAY_O2_INSP	MDC	1.4.1.152196	P	H	FiO ₂ is higher than or equal to the high alarm limit setting.
FiO ₂ Too Low	152196	MDC_CONC_AWAY_O2_INSP	MDC	1.4.1.152196	P	L	FiO ₂ is lower than or equal to the low alarm limit setting.
EtHal Too High	152092	MDC_CONC_AWAY_HALOTH_ET	MDC	1.4.1.152092	P	H	EtHal is higher than or equal to the high alarm limit setting.
EtHal Too Low	152092	MDC_CONC_AWAY_HALOTH_ET	MDC	1.4.1.152092	P	L	EtHal is lower than or equal to the low alarm limit setting.
FiHal Too High	152176	MDC_CONC_AWAY_HALOTH_INSP	MDC	1.4.1.152176	P	H	FiHal is higher than or equal to the high alarm limit setting.
FiHal Too Low	152176	MDC_CONC_AWAY_HALOTH_INSP	MDC	1.4.1.152176	P	L	FiHal is lower than or equal to the low alarm limit setting.
EtDes Too High	152084	MDC_CONC_AWAY_DESFL_ET	MDC	1.4.1.152084	P	H	EtDes is higher than or equal to the high alarm limit setting.
EtDes Too Low	152084	MDC_CONC_AWAY_DESFL_ET	MDC	1.4.1.152084	P	L	EtDes is lower than or equal to the low alarm limit setting.
FiDes Too High	152168	MDC_CONC_AWAY_DESFL_INSP	MDC	1.4.1.152168	P	H	FiDes is higher than or equal to the high alarm limit setting.

Alert	OBX-3.1	OBX-3.2	OBX-3.3	OBX-4	Type (P or T)	Threshold (H or L)	Description
FiDes Too Low	152168	MDC_CONC_AWAY_DESFL_INSP	MDC	1.4.1.152168	P	L	FiDes is lower than or equal to the low alarm limit setting.
EtEnf Too High	152088	MDC_CONC_AWAY_ENFL_ET	MDC	1.4.1.152088	P	H	EtEnf is higher than or equal to the high alarm limit setting.
EtEnf Too Low	152088	MDC_CONC_AWAY_ENFL_ET	MDC	1.4.1.152088	P	L	EtEnf is lower than or equal to the low alarm limit setting.
FiEnf Too High	152172	MDC_CONC_AWAY_ENFL_INSP	MDC	1.4.1.152172	P	H	FiEnf is higher than or equal to the high alarm limit setting.
FiEnf Too Low	152172	MDC_CONC_AWAY_ENFL_INSP	MDC	1.4.1.152172	P	L	FiEnf is lower than or equal to the low alarm limit setting.
EtSev Too High	152096	MDC_CONC_AWAY_SEVOFL_ET	MDC	1.4.1.152096	P	H	EtSev is higher than or equal to the high alarm limit setting.
EtSev Too Low	152096	MDC_CONC_AWAY_SEVOFL_ET	MDC	1.4.1.152096	P	L	EtSev is lower than or equal to the low alarm limit setting.
FiSev Too High	152180	MDC_CONC_AWAY_SEVOFL_INSP	MDC	1.4.1.152180	P	H	FiSev is higher than or equal to the high alarm limit setting.
FiSev Too Low	152180	MDC_CONC_AWAY_SEVOFL_INSP	MDC	1.4.1.152180	P	L	FiSev is lower than or equal to the low alarm limit setting.
EtIso Too High	152100	MDC_CONC_AWAY_ISOFL_ET	MDC	1.4.1.152100	P	H	EtIso is higher than or equal to the high alarm limit setting.
EtIso Too Low	152100	MDC_CONC_AWAY_ISOFL_ET	MDC	1.4.1.152100	P	L	EtIso is lower than or equal to the low alarm limit setting.
FiIso Too High	152184	MDC_CONC_AWAY_ISOFL_INSP	MDC	1.4.1.152184	P	H	FiIso is higher than or equal to the high alarm limit setting.

Alert	OBX-3.1	OBX-3.2	OBX-3.3	OBX-4	Type (P or T)	Threshold (H or L)	Description
Filso Too Low	152184	MDC_CONC_AWAY_ISOFL_INSP	MDC	1.4.1.152184	P	L	Filso is lower than or equal to the low alarm limit setting.
VtExp Too High	152664	MDC_VOL_AWAY_TIDAL_EXP	MDC	1.3.2.152664	P	H	VtExp is higher than or equal to the high alarm limit setting.
VtExp Too Low	152664	MDC_VOL_AWAY_TIDAL_EXP	MDC	1.3.2.152664	P	L	VtExp is lower than or equal to the low alarm limit setting.
Rate Too High	151570	MDC_AWAY_RESP_RATE	MDC	1.3.2.151570	P	H	Rate is higher than or equal to the high alarm limit setting.
Rate Too Low	151570	MDC_AWAY_RESP_RATE	MDC	1.3.2.151570	P	L	Rate is lower than or equal to the low alarm limit setting.

Table 22 Non-Threshold Alerts IDs

Alert	OBX-5.1	OBX-5.2	OBX-5.3	OBX-4	Type (P, T or A)	Description
Apnea	199680	MDC_EVT_APNEA	MDC	1.14.0.199680	P	Two triggering conditions are met simultaneously: 1. Paw is lower than (PEEP+3) cmH2O for more than 30 seconds. 2. TVe is lower than 10 ml for more than 30 seconds.
Apnea > 2 min	30018	MNDRY_EVT_VENT_RESP_APNEA_2_MIN	99MNDRY	1.14.0.30018	P	No breath has been detected within the last 120 seconds.
Apnea CO2	199680	MDC_EVT_APNEA	MDC	1.8.1.199680	P	Appear when no CO2 breath has been detected within the last CO2 Apnea Delay Time (10s-40s). And it shall be cleared as soon as one CO2 breath is detected.

Alert	OBX-5.1	OBX-5.2	OBX-5.3	OBX-4	Type (P, T or A)	Description
Pressure Limiting	30111	MNDRY_EVT_PRESSURE_LIMITING	99MNDRY	1.14.0.30111	P	Paw is greater than or equal to Plimit
Continuous Airway Pressure	30022	MNDRY_EVT_CONT_PRES_15_SEC	99MNDRY	1.14.0.30022	P	The Paw in the breathing circuit is greater than sustained airway pressure alarm limit for 15 seconds
Negative Pressure	30020	MNDRY_EVT_PRESS_AWAY_PSA	99MNDRY	1.14.0.30020	P	Paw is less than -10 cmH2O for 1 second.
Startup						
Bundle Version Error	30883	MNDRY_EVT_BUNDLE_VERSION_ERR	99MNDRY	1.14.0.30883	T	Current real software version unmatched with bundle version file.
Bundle Version : Timeout	30884	MNDRY_EVT_BUNDLE_VERSION_TIMEOUT	99MNDRY	1.14.0.30884	T	Bundle version selftest result cannot be obtained due to communication error.
Flowmeter Voltage Error	30720	MNDRY_EVT_ANALOG_FLOWMETER_VOLTAGE_ERR	99MNDRY	1.14.0.30720	T	DVCC, AVDD or VC voltage error.
Flowmeter Selftest Error	30190	MNDRY_EVT_SELFTEST_ERROR	99MNDRY	1.14.0.30190	T	1.CPU, Flash or WTD error. 2.Table blank or error.
Flowmeter Selftest: Timeout	30738	MNDRY_EVT_ANALOG_FLOWMETER_SENSOR_SELFTEST_TIMEOUT	99MNDRY	1.14.0.30738	T	Flowmeter selftest result cannot be obtained due to communication error.(A3,A5)

Alert	OBX-5.1	OBX-5.2	OBX-5.3	OBX-4	Type (P, T or A)	Description
Flowmeter Selftest Error	30190	MNDRY_EVT_SELFTEST_ERROR	99MNDRY	1.14.0.30190	T	1.CPU Selftest Error 2. RAM Selftest Error 3. Address line Selftest Error 4. Watchdog Selftest Error 5. Flash Selftest Error 6. O2 Proportional Valve Selftest Error 7. Air Proportional Valve Selftest Error 8. N2O Proportional Valve Selftest Error 9. O2 Branch Circuit Leakage 10. Air Branch Circuit Leakage 11. N2O Branch Circuit Leakage 12. Read Zero Error 13. FPGA Configure Error
Flowmeter Selftest: Time out	30738	MNDRY_EVT_ANES_FLOW_SENSOR_SELFTEST_TIMEOUT	99MNDRY	1.14.0.30738	T	Flowmeter selftest result cannot be obtained due to communication error.(A7)
Aux Control Module Selftest Error	30190	MNDRY_EVT_SELFTEST_ERROR	99MNDRY	1.14.0.30190	T	1.CPU, Flash, WTD error. 2.After power on, cpu board can't communicate with the Auxil Ctrl board.
Aux Control Module Selftest: Time out	30190	MNDRY_EVT_SELFTEST_ERROR	99MNDRY	1.14.0.30190	T	Aux control module selftest result cannot be obtained due to communication error.

Alert	OBX-5.1	OBX-5.2	OBX-5.3	OBX-4	Type (P, T or A)	Description
Ventilator Selftest Error	30190	MNDRY_EVT_SELFTEST_ERROR	99MNDRY	1.14.0.30190	T	1.CPU, TIMER, RAM, WTD, EEPROM or AD error 2.After power on, cpu board can't communicate with the ventilator board.
Ventilator Selftest: Time out	30190	MNDRY_EVT_SELFTEST_ERROR	99MNDRY	1.14.0.30190	T	Ventilator selftest result cannot be obtained due to communication error
Ventilator Voltage Error	30657	MNDRY_EVT_ANES_VENTILATOR_VOLTAGE_ERROR	99MNDRY	1.14.0.30657	T	5V or 12V voltage error
PEEP Valve Failure	30658	MNDRY_EVT_ANES_PEEP_VALVE_FAILURE	99MNDRY	1.14.0.30658	T	1. PEEP valve voltage error. 2. PEEP valve pressure error.
Insp Valve Failure	30661	MNDRY_EVT_ANES_INSP_VALVE_FAILURE	99MNDRY	1.14.0.30661	T	1. Insp valve voltage error. 2. Insp valve flow error.
Safety Valve Failure	30662	MNDRY_EVT_ANES_PEEP_SAFETY_VALVE_FAILURE	99MNDRY	1.14.0.30662	T	safety valve voltage error.
Flow Sensor Failure	30663	MNDRY_EVT_ANES_FLOW_SENSOR_FAILURE	99MNDRY	1.14.0.30663	T	Ventilator flow is out of range.
Calibrate Flow Sensor and Insp Valve	30724	MNDRY_EVT_ANES_CAL_DATA_ERROR	99MNDRY	1.14.0.30724	T	1.Cal. Table isn't found in EEPROM. 2.Checksum of Cal. Table don't match.

Alert	OBX-5.1	OBX-5.2	OBX-5.3	OBX-4	Type (P, T or A)	Description
Calibrate Pressure Sensor and PEEP Valve	30724	MNDRY_EVT _ANES_CAL_ DATA_ERR	99MND RY	1.14.0.30 724	T	1.Cal. Table isn't found in EEPROM. 2.Checksum of Cal. Table don't match.
Calibrate O2 Sensor	30670	MNDRY_EVT _ANES_CALI BRATE_O2_S ENSOR	99MND RY	1.14.0.30 670	T	1.Cal. Table isn't found in EEPROM. 2.Checksum of Cal. Table don't match.
Ventilator Initialization Error	30885	MNDRY_EVT _VENT_INIT_ ERR	99MND RY	1.14.0.30 885	T	After power on, cpu board can't send the parameter settings to ventilator board.
Ventilator Initialization: Timeout	30886	MNDRY_EVT _VENT_INIT_ TIMEOUT	99MND RY	1.14.0.30 886	T	Ventilator Initialization result cannot be obtained due to communication error
Drive Gas Pressure Low	30591	MNDRY_EVT _ANES_DIRV E_GAS_PRES SURE_LOW	99MND RY	1.14.0.30 591	T	Drive Gas Pressure Low
O2 Supply Failure	30592	MNDRY_EVT _ANES_O2_S UPPLY_FAIL URE	99MND RY	1.14.0.30 592	T	O2 Supply Failure
Power Supply Voltage Error	30428	MNDRY_EVT _POWER_BO ARD_VOL_ER ROR	99MND RY	1.14.0.30 428	T	3.3V, 5V, 12V voltage error
RT Clock Needs Battery	30887	MNDRY_EVT _RT_CLOCK_ BATT_FAIL	99MND RY	1.14.0.30 887	T	There is no button cell available in the system, or the battery is empty.

Alert	OBX-5.1	OBX-5.2	OBX-5.3	OBX-4	Type (P, T or A)	Description
RT Clock Failure	30433	MNDRY_EVT_RT_CLOCK_ERROR	99MNDRY	1.14.0.30433	T	RT chip malfunction.
Keyboard Self Test Error	30699	MNDRY_EVT_ANES_KEY_ERR	99MNDRY	1.14.0.30699	T	Keyboard Self Test Error
Keyboard Self Test : Time out	30699	MNDRY_EVT_ANES_KEY_ERR	99MNDRY	1.14.0.30699	T	Keyboard Self Test result cannot be obtained due to communication error
AG Startup						
External AG Self Test Error	30190	MNDRY_EVT_SELFTEST_ERROR	99MNDRY	1.9.0.30190	T	If the module sends the ErrorMsg, except for Data limit error and Unspecified Accuracy, "External AG Self Test Error" shall be triggered
Internal AG Error 02	30740	MNDRY_EVT_ANES_INTERNAL_AG_ERROR	99MNDRY	1.14.0.30740	T	If the module sends the ErrorMsg, except for Data limit error and Unspecified Accuracy, "Internal AG Error 02" shall be triggered
External AG: Time out	30190	MNDRY_EVT_SELFTEST_ERROR	99MNDRY	1.9.0.30190	T	External AG selftest result cannot be obtained due to communication error
Internal AG: Time out	30190	MNDRY_EVT_SELFTEST_ERROR	99MNDRY	1.14.0.30190	T	Internal AG selftest result cannot be obtained due to communication error
CPU Runtime						
IP Address Conflict	30381	MNDRY_EVT_IP_CONFLICT	99MNDRY	1.14.0.30381	T	The IP address is same with other machine in the local network.

Alert	OBX-5.1	OBX-5.2	OBX-5.3	OBX-4	Type (P, T or A)	Description
Fan Failure	30888	MNDRY_EVT_FAN_FAILURE	99MNDRY	1.14.0.30888	T	Speed of fan is less or equal 20% corresponding speed
Fan Failure 02	30888	MNDRY_EVT_FAN_FAILURE	99MNDRY	1.14.0.30888	T	Speed of Module Rack fan is less than 3640
ACGO Failure	30687	MNDRY_EVT_ANES_ACGO_FAILURE	99MNDRY	1.14.0.30687	T	ACGO switch status error
Power Board Runtime						
Power System Comm Stop	30889	MNDRY_EVT_POWER_SUPPLY_COMM_STOP	99MNDRY	1.14.0.30889	T	Lost communication with cpu board for 10 seconds.
Power Supply Voltage Error	30428	MNDRY_EVT_POWER_BOARD_VOLTAGE_ERROR	99MNDRY	1.14.0.30428	T	3.3V, 5V, 12V voltage error
Low Battery Voltage	30412	MNDRY_EVT_POWER_VOLTAGE_TOO_LOW	99MNDRY	1.14.0.30412	T	battery voltage is less than 10.6V for 5 seconds.
System going DOWN, Battery depleted!	196802	MDC_EVT_BATT_LO	MDC	1.14.0.196802	T	battery voltage is less than 10.2V.
Battery Undetected	30429	MNDRY_EVT_NO_BATTERY	99MNDRY	1.14.0.30429	T	Battery Undetected
Battery in Use	202884	MDC_EVT_STAT_DEV_BATTERY_OPERATED	MDC	1.14.0.202884	T	AC power fail
Power Board High Temp	30890	MNDRY_EVT_POWER_SUPPLY_TEMP_HIGH	99MNDRY	1.14.0.30890	T	Power board temp is greater than 95 C

Alert	OBX-5.1	OBX-5.2	OBX-5.3	OBX-4	Type (P, T or A)	Description
Heating Module Failure	30714	MNDRY_EVT _ANES_HEAT ING_MODUL E_FAILURE	99MND RY	1.14.0.30 714	T	1.Both resistance temps are greater than 105 C or less than 0 C for 20 seconds. 2. One of resistance temp is greater than 110 C for 15 seconds.
Breathing System Not Mounted	30714	MNDRY_EVT _ANES_POWE R_CIRCUIT_N O_MOUNT	99MND RY	1.14.0.30 714	T	Breathing system not mounted
Electronic Flowmeter Board Runtime						
Flowmeter Voltage Error	30715	MNDRY_EVT _ANES_FLOW METER_VOL TAGE_ERR	99MND RY	1.14.0.30 715	T	DVCC, AVDD or VC voltage error
N2O Flow Too High	30716	MNDRY_EVT _ANES_N2O_ FLOW_HI	99MND RY	1.14.0.30 716	T	N2O flow is greater than 15L/min for 1 second.
O2 Flow Too High	30717	MNDRY_EVT _ANES_O2_F LOW_HI	99MND RY	1.14.0.30 717	T	O2 flow is greater than 25L/min for 1 second.
Air Flow Too High	30718	MNDRY_EVT _ANES_AIR_F LOW_HI	99MND RY	1.14.0.30 718	T	Air flow is greater than 20L/min for 1 second.
O2-N2 O Ratio Error	30719	MNDRY_EVT _ANES_O2_N 2O_RATIO_E RR	99MND RY	1.14.0.30 719	T	N2O flow is greater than 0.5 L/min and greater than 4 times O2 flow, this condition last for 1.6 seconds.
Flowmeter Comm Stop	30720	MNDRY_EVT _ANES_FLOW METER_COM M_STOP	99MND RY	1.14.0.30 720	T	Lost communication with cpu board for 10 seconds.

Alert	OBX-5.1	OBX-5.2	OBX-5.3	OBX-4	Type (P, T or A)	Description
No Fresh Gas	30597	MNDRY_EVT _ANES_NO_F RESH_GAS	99MND RY	1.14.0.30 597	T	Fresh gas flow is less than 50 mL/min for 5 seconds when machine is not in Standby mode or Monitor mode.
Internal N2O Flow Failure	30721	MNDRY_EVT _ANES_INTE RNAL_N2O_S ENSOR_ERR	99MND RY	1.14.0.30 721	T	The I2C communication between CPU and N2O flow sensor failure
Internal O2 Flow Failure	30722	MNDRY_EVT _ANES_INTE RNAL_O2_SE NSOR_ERR	99MND RY	1.14.0.30 722	T	The I2C communication between CPU and O2 flow sensor failure
Internal Air Flow Failure	30723	MNDRY_EVT _ANES_INTE RNAL_AIR_S ENSOR_ERR	99MND RY	1.14.0.30 723	T	The I2C communication between CPU and Air flow sensor failure
Electronic Flow Control System Runtime						
Electronic Flow Control Error	30727	MNDRY_EVT _ANES_ELEC _FLOW_CTRL _ERR	99MND RY	1.14.0.30 727	T	CPU AVDD Power Voltage too low
	30727	MNDRY_EVT _ANES_ELEC _FLOW_CTRL _ERR	99MND RY	1.14.0.30 727	T	CPU AVDD Power Voltage too high
	30727	MNDRY_EVT _ANES_ELEC _FLOW_CTRL _ERR	99MND RY	1.14.0.30 727	T	CPU DVDD Power Voltage too low
	30727	MNDRY_EVT _ANES_ELEC _FLOW_CTRL _ERR	99MND RY	1.14.0.30 727	T	CPU DVDD Power Voltage too high
	30727	MNDRY_EVT _ANES_ELEC _FLOW_CTRL _ERR	99MND RY	1.14.0.30 727	T	CPU DVCC Power Voltage too high

Alert	OBX-5.1	OBX-5.2	OBX-5.3	OBX-4	Type (P, T or A)	Description
	30727	MNDRY_EVT _ANES_ELEC _FLOW_CTRL _ERR	99MND RY	1.14.0.30 727	T	CPU DVCC Power Voltage too low
	30727	MNDRY_EVT _ANES_ELEC _FLOW_CTRL _ERR	99MND RY	1.14.0.30 727	T	FPGA VPP Voltage too low
	30727	MNDRY_EVT _ANES_ELEC _FLOW_CTRL _ERR	99MND RY	1.14.0.30 727	T	FPGA VPP Voltage too high
	30727	MNDRY_EVT _ANES_ELEC _FLOW_CTRL _ERR	99MND RY	1.14.0.30 727	T	FPGA 3.3V Voltage too low
	30727	MNDRY_EVT _ANES_ELEC _FLOW_CTRL _ERR	99MND RY	1.14.0.30 727	T	FPGA 3.3V Voltage too high
	30727	MNDRY_EVT _ANES_ELEC _FLOW_CTRL _ERR	99MND RY	1.14.0.30 727	T	FPGA 1.2V Voltage too low
	30727	MNDRY_EVT _ANES_ELEC _FLOW_CTRL _ERR	99MND RY	1.14.0.30 727	T	FPGA 1.2V Voltage too high
	30727	MNDRY_EVT _ANES_ELEC _FLOW_CTRL _ERR	99MND RY	1.14.0.30 727	T	FPGA DVCC Voltage too low
	30727	MNDRY_EVT _ANES_ELEC _FLOW_CTRL _ERR	99MND RY	1.14.0.30 727	T	FPGA DVCC Voltage too high

Alert	OBX-5.1	OBX-5.2	OBX-5.3	OBX-4	Type (P, T or A)	Description
	30727	MNDRY_EVT _ANES_ELEC _FLOW_CTRL _ERR	99MND RY	1.14.0.30 727	T	Power AVCC Voltage too low
	30727	MNDRY_EVT _ANES_ELEC _FLOW_CTRL _ERR	99MND RY	1.14.0.30 727	T	Power AVCC Voltage too high
	30891	MNDRY_EVT _EFC_BFC_3 WAY_VALVE _ERROR	99MND RY	1.14.0.30 891	T	3-Way Valve Error
	30722	MNDRY_EVT _ANES_INTE RNAL_O2_SE NSOR_ERR	99MND RY	1.14.0.30 722	T	O2 Branch Flow Sensor Error
	30723	MNDRY_EVT _ANES_INTE RNAL_AIR_S ENSOR_ERR	99MND RY	1.14.0.30 723	T	Air Branch Flow Sensor Error
	30721	MNDRY_EVT _ANES_INTE RNAL_N2O_S ENSOR_ERR	99MND RY	1.14.0.30 721	T	N2O Branch Flow Sensor Error
	30736	MNDRY_EVT _ANES_O2_F LOW_UNACH IEVED	99MND RY	1.14.0.30 736	T	O2 Branch Flow not Achieved
	30737	MNDRY_EVT _ANES_GAS_ FLOW_UNAC HIEVED	99MND RY	1.14.0.30 737	T	Balance Gas Branch Flow not Achieved
	30792	MNDRY_EVT _BAL_GAS_B RANCH_TEM P_HI	99MND RY	1.14.0.30 792	T	Balance Gas Branch Temp. High

Alert	OBX-5.1	OBX-5.2	OBX-5.3	OBX-4	Type (P, T or A)	Description
	30793	MNDRY_EVT_O2_BRANCH_TEMP_HI	99MND RY	1.14.0.30793	T	O2 Branch Temp. High
	30727	MNDRY_EVT_ANES_ELEC_FLOW_CTRL_ERR	99MND RY	1.14.0.30727	T	FPGA Error
	30894	MNDRY_EVT_AUTO_TOTAL_FLOW_SENSOR_SELFTEST_FAIL	99MND RY	1.14.0.30894	T	Automatic total flow sensor self test failed
No Fresh Gas	30597	MNDRY_EVT_ANES_NO_FRESH_GAS	99MND RY	1.14.0.30597	T	No Fresh gas alarm shall be disabled for 5 seconds when machine is not in Standby mode, Monitor mode or Flow Paused state. (triggered by electronic flowmeters software) The alarm message “No Fresh Gas” shall be disabled during the first 5 seconds after exit Standby mode, Monitor mode or Flow Paused state. (For system software)
O2 Branch Flow Not Achieved	30736	MNDRY_EVT_ANES_O2_FLOW_UNACHIEVED	99MND RY	1.14.0.30736	T	O2 branch measured flow is over the O2 branch target flow \pm max (10%, 200mlpm)

Alert	OBX-5.1	OBX-5.2	OBX-5.3	OBX-4	Type (P, T or A)	Description
Balance Gas Branch Flow Not Achieved	30737	MNDRY_EVT _ANES_GAS_ FLOW_UNAC HIEVED	99MND RY	1.14.0.30 737	T	Balance branch measured flow is over the Balance branch target flow \pm max (10%, 200mlpm)
Backup Flow Control Deployment Failure	30730	MNDRY_EVT _ANES_BACK UP_FLOW_DE P_ERR	99MND RY	1.14.0.30 730	T	Solenoid Actuator Error
Backup Flow Control Retraction Failure	30731	MNDRY_EVT _ANES_BACK UP_FLOW_RE T_ERR	99MND RY	1.14.0.30 731	T	Stepper Motor Error
Air Supply Failure	30732	MNDRY_EVT _ANES_AIR_S UPPLY_FAIL	99MND RY	1.14.0.30 732	T	Air Supply Pressure Low
N2O Supply Failure	30733	MNDRY_EVT _ANES_N2O_ SUPPLY_FAIL	99MND RY	1.14.0.30 733	T	N2O Supply Pressure Low
Backup Flow Control Valves Open	30734	MNDRY_EVT _ANES_BACK UP_FLOW_V ALVE_OPEN	99MND RY	1.14.0.30 734	T	Needle Vavle is not closed
	30734	MNDRY_EVT _ANES_BACK UP_FLOW_V ALVE_OPEN	99MND RY	1.14.0.30 734	T	BFCS is not closed
Backup Flow Control is enabled	30735	MNDRY_EVT _ANES_BACK UP_FLOW_EN ABLED	99MND RY	1.14.0.30 735	T	Backup Flow Control is enabled

Alert	OBX-5.1	OBX-5.2	OBX-5.3	OBX-4	Type (P, T or A)	Description
Flowmeter Comm Stop	30720	MNDRY_EVT _ANES_FLOW METER_COM M_STOP	99MND RY	1.14.0.30 720	T	Lost communication with cpu board for 10 seconds.The Flowmeter Comm Stop shall be detected by both Main board CPU and Flowmeter CPU.
Keyboard Comm Stop	30699	MNDRY_EVT _ANES_KEY_ ERR	99MND RY	1.14.0.30 699	T	Lost communication with cpu board for 10 seconds.
Total Flow Sensor Self Test Time Out	30738	MNDRY_EVT _ANES_FLOW _SENSOR_SE LFT_TIMEOU T	99MND RY	1.14.0.30 738	T	Automatic total flow sensor self test time out occurs
Backup Flow Control Error	30728	MNDRY_EVT _ANES_BACK UP_FLOW_CR TL_ERR	99MND RY	1.14.0.30 728	T	BFCS Deployment Position sensor Error
	30728	MNDRY_EVT _ANES_BACK UP_FLOW_CR TL_ERR	99MND RY	1.14.0.30 728	T	BFCS Retraction Position sensor Error
	30728	MNDRY_EVT _ANES_BACK UP_FLOW_CR TL_ERR	99MND RY	1.14.0.30 728	T	LED Power Voltage too low
	30728	MNDRY_EVT _ANES_BACK UP_FLOW_CR TL_ERR	99MND RY	1.14.0.30 728	T	LED Power Voltage too high
	30728	MNDRY_EVT _ANES_BACK UP_FLOW_CR TL_ERR	99MND RY	1.14.0.30 728	T	BFCS/EFCS 3-Way Valve Error

Alert	OBX-5.1	OBX-5.2	OBX-5.3	OBX-4	Type (P, T or A)	Description
Ventilator Control Board						
Aux Control Module Comm Stop	30688	MNDRY_EVT _ANES_AUX_ MODULE_CO MM_STOP	99MND RY	1.14.0.30 688	T	Lost communication with cpu board for 10 seconds.
Ventilator Voltage Error	30657	MNDRY_EVT _ANES_VENT ILATOR_VOL TAGE_ERR	99MND RY	1.14.0.30 657	T	5V or 12V voltage error
PEEP Valve Failure	30658	MNDRY_EVT _ANES_PEEP_ VAVLE_FAIL URE	99MND RY	1.14.0.30 658	T	1. PEEP valve voltage error. 2. PEEP valve pressure error.
Insp Valve Failure	30661	MNDRY_EVT _ANES_INSP_ VALVE_FAIL URE	99MND RY	1.14.0.30 661	T	1. Insp valve voltage error. 2. Insp valve flow error.
Safety Valve Failure	30662	MNDRY_EVT _ANES_PEEP_ SAFETY_VAL VE_FAILURE	99MND RY	1.14.0.30 662	T	Safety valve voltage error.
Flow Sensor Failure	30663	MNDRY_EVT _ANES_FLOW_ SENSOR_FAI LURE	99MND RY	1.14.0.30 663	T	1. Insp flow is out of range. 2. Exp flow is out of range.
Check Flow Sensors	30664	MNDRY_EVT _ANES_CHEC K_FLOW_SEN SORS	99MND RY	1.14.0.30 664	T	1. Insp reverse flow 2. Exp reverse flow
Pinsp Not Achieved	30665	MNDRY_EVT _ANES_PINSP_ NOT_ACHIE VED	99MND RY	1.14.0.30 665	T	Ppeak don't reach the setting Pinsp in pressure mode.
Vt Not Achieved	30666	MNDRY_EVT _ANES_VT_N OT_ACHIEVE D	99MND RY	1.14.0.30 666	T	Vt didn't reach the setting Vt in volume mode.

Alert	OBX-5.1	OBX-5.2	OBX-5.3	OBX-4	Type (P, T or A)	Description
ACGO 3-way Valve Failure	30687	MNDRY_EVT _ANES_ACGO _3WAY_VAL VE_FAILURE	99MND RY	1.14.0.30 687	T	ACGO 3-way Valve status is error.
Automatic Ventilation Disabled	30694	MNDRY_EVT _ANES_AUTO MATIC_VENT _DISABLED	99MND RY	1.14.0.30 694	T	Power on self test failed, and the result is "Manual Only".
Automatic Ventilation Disabled-Leak Test Failed	30695	MNDRY_EVT _ANES_AUTO _VENT_DISA BLED_LEAK_ FAIL	99MND RY	1.14.0.30 695	T	Automatic/Manual circuit leak test failed, and the result is "Manual Only".
Automatic Ventilation is Non-Functional	30696	MNDRY_EVT _ANES_AUTO _VENT_NON_ FUNCTIONAL	99MND RY	1.14.0.30 696	T	When system is in the Automatic Ventilation Non-functional state
Electronic ACGO Undetected	30698	MNDRY_EVT _ANES_NO_E LEC_ACGO	99MND RY	1.14.0.30 698	T	Electronic ACGO configuration incompatible with hardware.
Patient Circuit Leak	30589	MNDRY_EVT _ANES_PAT_ CIRCUIT_LEA K	99MND RY	1.14.0.30 589	T	1. Vte is less than Vti to the maximum of 200ml and 50% for 30 seconds 2. Vti is less than Vt delivery in volume mode. 3. Patient not connected.

Alert	OBX-5.1	OBX-5.2	OBX-5.3	OBX-4	Type (P, T or A)	Description
CO2 Absorber Canister Not Locked	30667	MNDRY_EVT _ANES_CO2_ CANISTER_N OT_MOUNTE D	99MND RY	1.14.0.30 667	T	CO2 Canister Not Mounted
O2 Sensor Disconnected	30590	MNDRY_EVT _ANES_NO_O 2_SENSOR	99MND RY	1.14.0.30 590	T	No O2 sensor is connected (the O2 sensor can be a galvanic O2 sensor or a paramagnetic O2 sensor)
Replace O2 sensor	30668	MNDRY_EVT _ANES_REPL ACE_O2_SEN SOR	99MND RY	1.14.0.30 668	T	The O2 value is less than 5%
Perform 100% O2 Sensor Calibration	30708	MNDRY_EVT _ANES_CAL_ O2_FOR_100	99MND RY	1.14.0.30 708	T	O2 value is greater than 110% or between 5% and 15% for 3 seconds.
Ventilator Comm Stop	30671	MNDRY_EVT _ANES_VENT ILATOR_COM M_STOP	99MND RY	1.14.0.30 671	T	Lost communication with cpu board for 10 seconds.
Drive Gas Pressure Low	30591	MNDRY_EVT _ANES_DIRV E_GAS_PRES SURE_LOW	99MND RY	1.14.0.30 591	T	Drive Gas Pressure Low
O2 Supply Failure	30592	MNDRY_EVT _ANES_O2_S UPPLY_FAIL URE	99MND RY	1.14.0.30 592	T	O2 Supply Failure
Fresh Gas Flow Too High	30685	MNDRY_EVT _ANES_FRES H_GAS_FLO W_HI	99MND RY	1.14.0.30 685	T	In VCV and SIMV-VC modes, the fresh gas flow is greater than or equal to flow needed.
AG Module						

Alert	OBX-5.1	OBX-5.2	OBX-5.3	OBX-4	Type (P, T or A)	Description
AG Hardware Error	30349	MNDRY_EVT_AG_HARDWARE_ERROR	99MNDRY	1.9.0.30349	T	/
O2 Sensor Error	30744	MNDRY_EVT_ANES_O2_SENSOR_ERR	99MNDRY	1.9.0.30744	T	/
External AG Self Test Error	30190	MNDRY_EVT_SELFTEST_ERROR	99MNDRY	1.9.0.30190	T	/
AG Hardware Malfunction	30745	MNDRY_EVT_ANES_AG_HARDWARE_MALFUNCION	99MNDRY	1.9.0.30745	T	/
AG Init Error	30189	MNDRY_EVT_INIT_ERROR	99MNDRY	1.9.0.30189	T	/
AG No Water trap	30345	MNDRY_EVT_AG_NO_WATERTRAP	99MNDRY	1.9.0.30345	T	/
AG Water trap Type Wrong	30347	MNDRY_EVT_AG_WRONG_WATERTRAP	99MNDRY	1.9.0.30347	T	When the patient type is infant, but the water trap type is adult/ pediatric, this alarm will be triggered.
AG Change Water trap	30346	MNDRY_EVT_AG_CHANGE_WATERTRAP	99MNDRY	1.9.0.30346	T	/
AG Comm Stop	30191	MNDRY_EVT_COMM_STOP	99MNDRY	1.9.0.30191	T	/
AG Airway Occluded	30348	MNDRY_EVT_AG_OCCLUSION	99MNDRY	1.9.0.30348	T	Pump rate is lower than 20ml/min for 1 second

Alert	OBX-5.1	OBX-5.2	OBX-5.3	OBX-4	Type (P, T or A)	Description
AG Zero Failed	30356	MNDRY_EVT_AG_ZEROING_FAILED	99MNDRY	1.9.0.30356	T	Gas measurements may have bad accuracy during Zeroing
Mixed Agent	30128	MNDRY_EVT_MIX_GAS	99MNDRY	1.9.0.30128	T	MAC<3
Mixed Agent	30128	MNDRY_EVT_MIX_GAS	99MNDRY	1.9.0.30128	T	When there is an invalid MAC value and there is mixed agent at the same time, system shall trigger this alarm
Mixed Agent and MAC ≥ 3	30743	MNDRY_EVT_ANES_INVALID_MAC_VALUE	99MNDRY	1.14.0.30743	T	MAC ≥ 3
External AG Module Disconnected	30368	MNDRY_EVT_AG_NOT_CONNECTED	99MNDRY	1.9.0.30368	T	When external AG is unload for the A7
Incompatible AG Software Version	30697	MNDRY_EVT_ANES_INCOMPATIBLE_AG_SW	99MNDRY	1.14.0.30697	T	When the AG Version Limit is On, and the AG module is loaded while the AG software version is lower than 1.7.3.0, this alarm will be triggered.
CO2 Over Range	30895	MNDRY_EVT_CO2_OUT_OF_RANGE	99MNDRY	1.14.0.30895	T	CO2 is outside of its measurable range.
N2O Over Range	30896	MNDRY_EVT_N2O_OUT_OF_RANGE	99MNDRY	1.14.0.30896	T	N2O is outside of its measurable range.
Hal Over Range	30898	MNDRY_EVT_HAL_OUT_OF_RANGE	99MNDRY	1.14.0.30898	T	O2 is outside of its measurable range.
Enf Over Range	30899	MNDRY_EVT_ENF_OUT_OF_RANGE	99MNDRY	1.14.0.30899	T	Halothane is outside of measurable range.

Alert	OBX-5.1	OBX-5.2	OBX-5.3	OBX-4	Type (P, T or A)	Description
Iso Over Range	30900	MNDRY_EVT_ISO_OUT_OF_RANGE	99MND RY	1.14.0.30 900	T	Desflurane is outside of measurable range.
Sev Over Range	30901	MNDRY_EVT_SEV_OUT_OF_RANGE	99MND RY	1.14.0.30 901	T	Enflurane is outside of itsmeasurable range.
Des Over Range	30902	MNDRY_EVT_DES_OUT_OF_RANGE	99MND RY	1.14.0.30 902	T	Sevoflurane is outside of its measurable range.
O2 Over Range	30897	MNDRY_EVT_O2_OUT_OF_RANGE	99MND RY	1.14.0.30 897	T	Isoflurane is outside of its measurable range.
Rate Over Range	30746	MNDRY_EVT_ANES_RATE_OVER_RANGE	99MND RY	1.14.0.30 746	T	The monitoring value of Rate (AG) exceeds the measurable range. When this kind of alarm is triggered, "---" will be displayed
Internal AG Error 01	30349	MNDRY_EVT_AG_HARDWARE_ERROR	99MND RY	1.14.0.30 349	T	Internal AG Hardware Error
Internal AG Error 02	30740	MNDRY_EVT_ANES_INTERNAL_AG_ERROR	99MND RY	1.14.0.30 740	T	Internal AG Selftest Error
Internal AG Error 03	30349	MNDRY_EVT_AG_HARDWARE_ERROR	99MND RY	1.14.0.30 349	T	Internal AG Hardware Malfunction
Internal AG Error 04	30740	MNDRY_EVT_ANES_INTERNAL_AG_ERROR	99MND RY	1.14.0.30 740	T	Internal AG Init Error
Internal AG Error 05	30740	MNDRY_EVT_ANES_INTERNAL_AG_ERROR	99MND RY	1.14.0.30 740	T	Internal AG Comm Stop

Alert	OBX-5.1	OBX-5.2	OBX-5.3	OBX-4	Type (P, T or A)	Description
Internal AG Error 07	30356	MNDRY_EVT_AG_ZEROING_FAILED	99MNDRY	1.14.0.30356	T	Internal AG Zero Failed
Internal AG Error 09	30345	MNDRY_EVT_AG_NO_WATERTRAP	99MNDRY	1.14.0.30345	T	Internal AG No Watertrap
Internal AG Error 10	30348	MNDRY_EVT_AG_OCCLUSION	99MNDRY	1.14.0.30348	T	Internal AG Airway Occluded
Internal AG Error 11	30346	MNDRY_EVT_AG_CHANGE_WATERTRAP	99MNDRY	1.14.0.30346	T	Internal AG Change Watertrap
Pressure Monitoring Chanel Failure	31015	MNDRY_EVT_VENT_PRESS_SENSOR_ERROR	99MNDRY	1.14.0.31015	T	1. Monitored value of PEEP sensor or Paw Sensor is out of range. 2. Zero of PEEP sensor or Paw Sensor is abnormal 3. PEEP sensor is reversely connected
Aux Control Module Voltage Error	30428	MNDRY_EVT_POWER_BOARD_VOLTAGE_ERROR	99MNDRY	1.14.0.30428	T	VPM 1.3V voltage error

FOR YOUR NOTES

C A-Series HL7 Simulator Instructions

C.1 Overview

The A-Series Simulator is designed as a demo tool based on Mindray A-Series anesthesia systems, and it is mainly for the software developers and/or systems integrators that wish to communicate with Mindray A-Series anesthesia systems that have software bundle version 02.11.00.

Before using it, the user should install the **A-Series Simulator** correctly in their PC or laptop first.

C.2 Simulator Setup

Right clicking the mouse on the simulator screen will open a dialog (see figure below), by which the user can see the available features and possible to change its configuration.



Device Setting

The Device Setting dialog will look like:

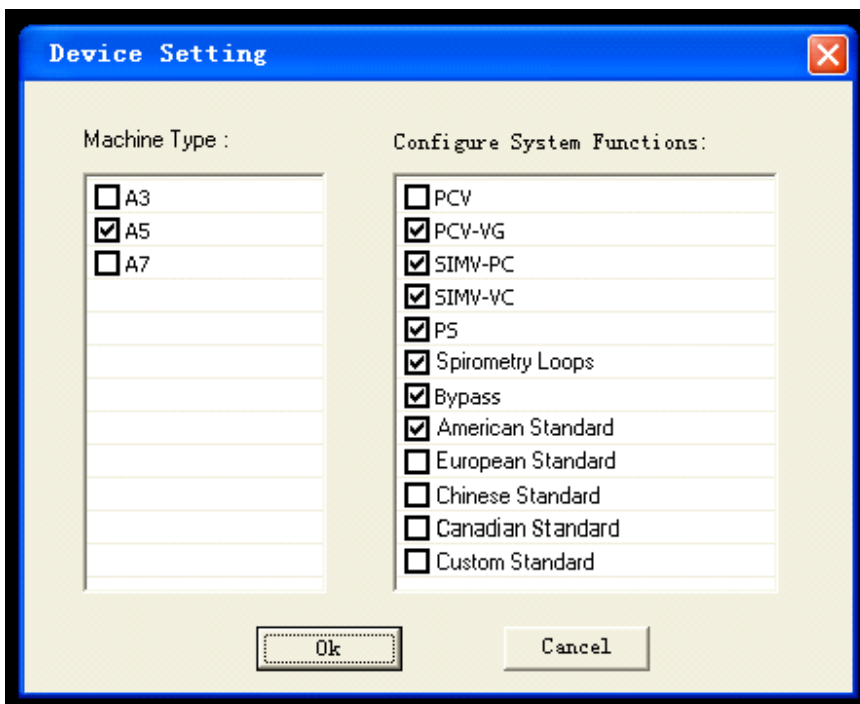

By device setting dialog, the user can change the machine type as well as configure the system functions. Any changes on Device Setting can only take effect after the simulator reboot.

About

The About dialog will look like:

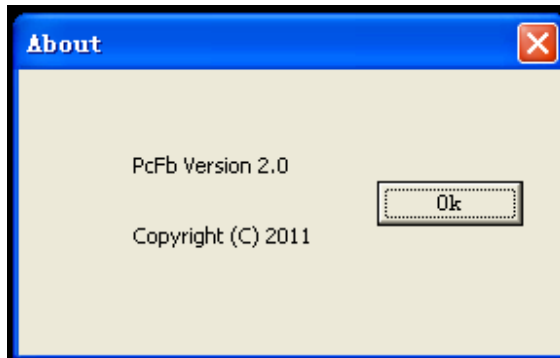

Exit

Click the **Exit** to exit the simulator.

C.3 Keyboard Shortcuts

For A3/A5/A7

- The user can switch the Auto/Manual state via the “m” key in keyboard.

For A3/A5 only

- The user can turn ON/OFF the fresh gas flow via the “f” key in keyboard.

